

## Preiskatalog / Prix courant 2010-UIK-07-01

GLEITLAGER  
SEITEN 219-247

PALIERS LISSES  
PAGES 219-247

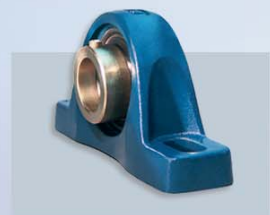

Gültig ab 1.8.2008  
(ersetzt 2006-UIK-06 vom 1.3.2006)  
Preisänderungen vorbehalten!

Valable dès 1.8.2008  
(remplace 2006-UIK-06 du 1.3.2006)  
Changement de prix réservé!

# Inhalt

# Sommaire

	Seiten		Pages
<b>Inhaltsverzeichnis alphabetisch</b>	<b>III–XII</b>	<b>Répertoire alphabétique</b>	<b>III–XII</b>
<b>Wälzlager metrisch und Zubehör (07-01)</b>	<b>1-57</b>	<b>Roulements dimensions métriques et accessoires (07-01)</b>	<b>1-57</b>
- Schulterkugellager	1	- Roulements à billes démontables	1
- Rillenkugellager	2-11	- Roulements rigides à billes	2-11
- Schrägkugellager	12-17	- Roulements à billes contact oblique	12-17
- Pendelkugellager	18-23	- Roulements à rotule sur billes	18-23
- Vierpunktlager	24	- Roulements à quatre points de contact	24
- Pendelrollenlager	25-30	- Roulements à rotule sur rouleaux	25-30
- Axial-Pendelrollenlager	31	- Butées à rotule sur rouleaux	31
- Zylinderrollenlager	32-37	- Roulements à rouleaux cylindriques	32-37
- Kegelrollenlager	38-41	- Roulements à rouleaux coniques	38-41
- Axial-Rillenkugellager	42-46	- Butées à billes	42-46
- Spannhülsen	47-48	- Manchons de serrage	47-48
- Abziehhülsen	49-50	- Manchons de démontage	49-50
- Wellenmuttern und Sicherungsbleche	51	- Ecrous et rondelles-frein	51
- Stehlagergehäuse geteilt	52-57	- Paliers en deux parties	52-57
<b>Wälzlager in Zollabmessung (07-01)</b>	<b>58-91</b>	<b>Roulements dimensions pouces (07-01)</b>	<b>58-91</b>
- Rillenkugellager	58-61	- Roulements rigides à billes	58-61
- Schrägkugellager	62-63	- Roulements à billes à contact oblique	62-63
- Pendelkugellager	64-65	- Roulements à rotule sur billes	64-65
- Vierpunktlager	66-67	- Roulements à quatre points de contact	66-67
- Zylinderrollenlager	68-72	- Roulements à rouleaux cylindriques	68-72
- Axial-Rillenkugellager	73-77	- Butées à billes	73-77
- Kegelrollenlager	78-91	- Roulements à rouleaux coniques	78-91
<b>Gehäuselager (07-01)</b>	<b>92-132</b>	<b>Paliers et roulements (07-01)</b>	<b>92-132</b>
- Typenübersicht Gehäuselager und Lagereinsätze mit Spannring	92-93	- Tableau des paliers et roulements à billes avec bague de blocage excentrée	92-93
- Typenübersicht Gehäuselager und Lagereinsätze mit Befestigungsschrauben oder Spannhülsen	94-101	- Tableau des paliers et roulements à billes avec fixation par vis ou manchons de serrage	94-101
- Laufrollen und Riemenspannrollen	102	- Galets d'appui et poulies de tension	102
- Kettenspannräder	103	- Pignons tendeurs de chaîne	103
- Gehäuselager	104-132	- Paliers de roulement à billes	104-132
<b>Gelenklager und Gelenkköpfe (07-01)</b>	<b>133-154</b>	<b>Rotules et embouts à rotule (07-01)</b>	<b>133-154</b>
- Gelenklager	133-139	- Rotules	133-139
- Schräg-Gelenklager	140	- Rotules à contact oblique	140
- Axial-Gelenklager	141-142	- Rotules axiales	141-142
- Gelenkköpfe	143-150	- Embouts à rotule	143-150
- Hydraulik-Gelenkköpfe	151-154	- Embouts à rotule hydrauliques et à billes à contact oblique	151-154

# Inhalt

# Sommaire

	Seiten		Pages
<b>Nadellager metrisch (07-01)</b>	155-198	<b>Roulements à aiguilles dimensions métriques (07-01)</b>	155-198
- Nadelkränze	155-160	- Cages à aiguilles	155-160
- Nadelhülsen und Nadelbüchsen	161-163	- Douilles à aiguilles avec et sans fond	161-163
- Nadellager ohne Innenring	164-168	- Roulements à aiguilles sans bague intérieure	164-168
- Nadellager ohne Borde, ohne Innenring	169	- Roulements à aiguilles sans épaulements sans bague intérieure	169
- Nadellager mit Innenring	170-174	- Roulements à aiguilles avec bague intérieure	170-174
- Nadellager ohne Borde, mit Innenring	175	- Roulements à aiguilles sans épaulements avec bague intérieure	175
- Stützrollen mit und ohne Axialführung, mit und ohne Innenring	176-182	- Galets d'appui avec et sans guidage axial, avec et sans bague intérieure	176-182
- Kurvenrollen	183-185	- Galets de came	183-185
- Nadel-Schräggugellager	186-187	- Roulements combinés à aiguilles et à billes à contact oblique	186-187
- Nadel-Axial-Rillenkugellager	188	- Roulements à aiguilles combinés avec butée à billes	188
- Nadel-Axial-Zylinderrollenlager	189	- Roulements à aiguilles combinés avec butée à rouleaux cylindriques	189
- Axial-Nadelkränze, Lagerscheiben und Laufscheiben	190-191	- Cages de butée à aiguilles, rondelles minces et rondelles de butée	190-191
- Axial-Zylinderrollenlager	192-193	- Butées à rouleaux cylindriques	192-193
- Innenringe	194-197	- Bagues intérieures	194-197
- Dichtringe	198	- Joints d'étanchéité	198
<b>Miniatürkugellager (07-01)</b>	199-209	<b>Roulements miniatures à billes (07-01)</b>	199-209
- Miniaturrillenkugellager	199-208	- Roulements miniatures à billes	199-208
- Miniatur Axialkugellager	209	- Butées miniatures à billes	209
<b>Linearlager (07-01)</b>	210-218	<b>Guidage linéaire (07-01)</b>	210-218
- Kugelbüchsen	210-218	- Douilles à billes	210-218
<b>Gleitlager (07-01)</b>	219-247	<b>Paliers lisses (07-01)</b>	219-247
- Gleitlager	219-247	- Paliers lisses	219-247
<b>Zubehör (07-01)</b>	248-278	<b>Accessoires (07-01)</b>	248-278
- Kugeln	248-249	- Billes	248-249
- Zylinderrollen	250	- Rouleaux cylindriques	250
- Nadelrollen	251	- Aiguilles	251
- Typenübersicht Wellendichtungen	252	- Tableau des types de joints d'étanchéité	252
- Wellendichtungen metrisch	253-255	- Joints d'étanchéité métriques	253-255
- Wellenschutzhülsen	256-266	- Douilles de protection d'arbre	256-266
- Produkte für Montage, Unterhalt und Reparatur	267-277	- Produits pour assemblage, entretien et réparation	267-277
- Wälzlagerfette	278	- Graisses pour roulements	278
<b>Notizen / Geschäftsbedingungen (07-01)</b>	279-282	<b>Notes / Conditions générales (07-01)</b>	279-282
- Notizen	279-280	- Notes	279-280
- Allgemeine Geschäftsbedingungen	281-282	- Conditions générales de vente	281-282

Gleitlager-Buchsen  
wartungsfrei, mit Stahlrücken

Palier lisse radial  
sans entretien, avec support en acier

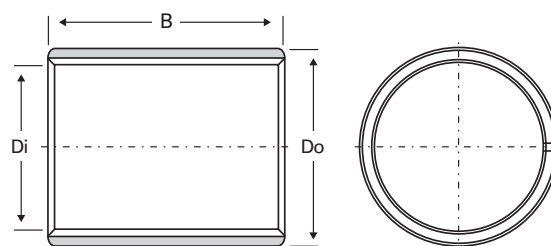

Reihen | **PAP . . P10**  
Séries

Welle Arbre Ø mm	Typ Type		Masse in mm Dimensions en mm			Preis Prix CHF
			Di	Do	B	
2	<b>PAP 0203 P10</b>		2	3,5	3	0.78
	<b>PAP 0205 P10</b>		2	3,5	5	0.80
3	<b>PAP 0303 P10</b>	MU TFP 03 04.5 03	3	4,5	3	0.83
	<b>PAP 0304 P10</b>	MU TFP 03 04.5 04	3	4,5	4	0.87
	<b>PAP 0305 P10</b>	MU TFP 03 04.5 05	3	4,5	5	0.87
	<b>PAP 0306 P10</b>	MU TFP 03 04.5 06	3	4,5	6	0.92
4	<b>PAP 0403 P10</b>	MU TFP 04 05.5 03	4	5,5	3	0.87
	<b>PAP 0404 P10</b>	MU TFP 04 05.5 04	4	5,5	4	0.92
	<b>PAP 0406 P10</b>	MU TFP 04 05.5 06	4	5,5	6	0.94
	<b>PAP 0410 P10</b>	MU TFP 04 05.5 10	4	5,5	10	1.14
5	<b>PAP 0505 P10</b>	MU TFP 05 07 05	5	7	5	0.94
	<b>PAP 0508 P10</b>	MU TFP 05 07 08	5	7	8	1.20
	<b>PAP 0510 P10</b>	MU TFP 05 07 10	5	7	10	1.23
6		MU TFP 06 08 04	6	8	4	*
	<b>PAP 0606 P10</b>	MU TFP 06 08 06	6	8	6	1.08
	<b>PAP 0608 P10</b>	MU TFP 06 08 08	6	8	8	1.20
	<b>PAP 0610 P10</b>		6	8	10	1.20
7	<b>PAP 0710 P10</b>	MU TFP 07 09 10	7	9	10	1.32
8		MU TFP 08 10 06	8	10	6	*
	<b>PAP 0808 P10</b>	MU TFP 08 10 08	8	10	8	1.14
	<b>PAP 0810 P10</b>	MU TFP 08 10 10	8	10	10	1.35
	<b>PAP 0812 P10</b>	MU TFP 08 10 12	8	10	12	1.47
10	<b>PAP 1008 P10</b>	MU TFP 10 12 08	10	12	8	1.53
	<b>PAP 1010 P10</b>	MU TFP 10 12 10	10	12	10	1.82
	<b>PAP 1012 P10</b>	MU TFP 10 12 12	10	12	12	2.15
	<b>PAP 1015 P10</b>	MU TFP 10 12 15	10	12	15	2.34
	<b>PAP 1020 P10</b>	MU TFP 10 12 20	10	12	20	3.10
12	<b>PAP 1208 P10</b>	MU TFP 12 14 08	12	14	8	2.39
	<b>PAP 1210 P10</b>	MU TFP 12 14 10	12	14	10	2.46
	<b>PAP 1212 P10</b>	MU TFP 12 14 12	12	14	12	2.71
	<b>PAP 1215 P10</b>	MU TFP 12 14 15	12	14	15	2.95
	<b>PAP 1220 P10</b>	MU TFP 12 14 20	12	14	20	3.38
	<b>PAP 1225 P10</b>	MU TFP 12 14 25	12	14	25	3.75

Gleitlager-Buchsen  
wartungsfrei, mit Stahlrücken

Palier lisse radial  
sans entretien, avec support en acier

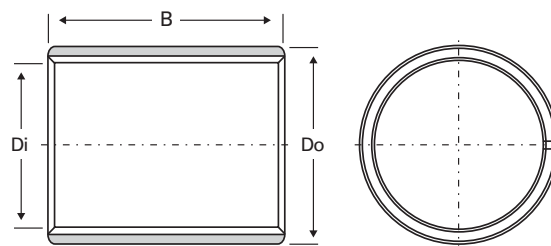

Reihen | **PAP . . P10**  
Séries

Welle Arbre Ø mm	Typ Type		Masse in mm Dimensions en mm			Preis Prix CHF
			Di	Do	B	
<b>13</b>	<b>PAP 1310 P10</b>	MU TFP 13 15 10	13	15	10	2.83
		MU TFP 13 15 20	13	15	20	*
<b>14</b>		MU TFP 14 16 05	14	16	5	*
	<b>PAP 1410 P10</b>	MU TFP 14 16 10	14	16	10	2.81
	<b>PAP 1412 P10</b>	MU TFP 14 16 12	14	16	12	2.93
	<b>PAP 1415 P10</b>	MU TFP 14 16 15	14	16	15	3.02
	<b>PAP 1420 P10</b>	MU TFP 14 16 20	14	16	20	3.42
	<b>PAP 1425 P10</b>	MU TFP 14 16 25	14	16	25	3.94
<b>15</b>	<b>PAP 1510 P10</b>	MU TFP 15 17 10	15	17	10	3.10
	<b>PAP 1512 P10</b>	MU TFP 15 17 12	15	17	12	3.23
	<b>PAP 1515 P10</b>	MU TFP 15 17 15	15	17	15	3.49
	<b>PAP 1520 P10</b>	MU TFP 15 17 20	15	17	20	3.68
	<b>PAP 1525 P10</b>	MU TFP 15 17 25	15	17	25	4.20
<b>16</b>	<b>PAP 1610 P10</b>	MU TFP 16 18 10	16	18	10	3.10
	<b>PAP 1612 P10</b>	MU TFP 16 18 12	16	18	12	3.42
	<b>PAP 1615 P10</b>	MU TFP 16 18 15	16	18	15	3.49
	<b>PAP 1620 P10</b>	MU TFP 16 18 20	16	18	20	4.16
	<b>PAP 1625 P10</b>	MU TFP 16 18 25	16	18	25	4.82
<b>17</b>		MU TFP 17 19 15	17	19	15	*
		MU TFP 17 19 20	17	19	20	*
<b>18</b>	<b>PAP 1810 P10</b>	MU TFP 18 20 10	18	20	10	3.59
	<b>PAP 1815 P10</b>	MU TFP 18 20 15	18	20	15	3.99
	<b>PAP 1820 P10</b>	MU TFP 18 20 20	18	20	20	4.51
	<b>PAP 1825 P10</b>	MU TFP 18 20 25	18	20	25	5.06
<b>20</b>		MU TFP 20 22 10	20	22	10	*
		MU TFP 20 22 15	20	22	15	*
		MU TFP 20 22 20	20	22	20	*
	<b>PAP 2010 P10</b>	MU TFP 20 23 10	20	23	10	4.16
	<b>PAP 2015 P10</b>	MU TFP 20 23 15	20	23	15	4.32
	<b>PAP 2020 P10</b>	MU TFP 20 23 20	20	23	20	4.63
	<b>PAP 2025 P10</b>	MU TFP 20 23 25	20	23	25	5.50
	<b>PAP 2030 P10</b>	MU TFP 20 23 30	20	23	30	6.14

Gleitlager-Buchsen  
wartungsfrei, mit Stahlrücken

Palier lisse radial  
sans entretien, avec support en acier

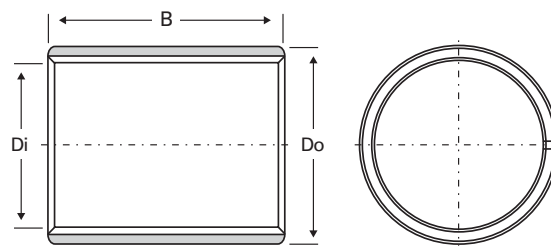

Reihen | **PAP . . P10**  
Séries

Welle Arbre Ø mm	Typ Type		Masse in mm Dimensions en mm			Preis Prix CHF
			Di	Do	B	
<b>22</b>	<b>PAP 2215 P10</b>	MU TFP 22 25 15	22	25	15	4.47
	<b>PAP 2220 P10</b>	MU TFP 22 25 20	22	25	20	5.08
	<b>PAP 2225 P10</b>	MU TFP 22 25 25	22	25	25	5.96
	<b>PAP 2230 P10</b>	MU TFP 22 25 30	22	25	30	6.64
<b>24</b>	<b>PAP 2415 P10</b>	MU TFP 24 27 15	24	27	15	5.70
	<b>PAP 2420 P10</b>	MU TFP 24 27 20	24	27	20	6.43
	<b>PAP 2425 P10</b>	MU TFP 24 27 25	24	27	25	7.23
	<b>PAP 2430 P10</b>	MU TFP 24 27 30	24	27	30	7.94
		MU TFP 24 28 15	24	28	15	*
		MU TFP 24 28 20	24	28	20	*
		MU TFP 24 28 25	24	28	25	*
		MU TFP 24 28 30	24	28	30	*
<b>25</b>	<b>PAP 2510 P10</b>		25	28	10	3.88
		MU TFP 25 28 12	25	28	12	*
	<b>PAP 2515 P10</b>	MU TFP 25 28 15	25	28	15	5.74
	<b>PAP 2520 P10</b>	MU TFP 25 28 20	25	28	20	6.31
	<b>PAP 2525 P10</b>	MU TFP 25 28 25	25	28	25	7.20
	<b>PAP 2530 P10</b>	MU TFP 25 28 30	25	28	30	8.17
	<b>PAP 2540 P10</b>	MU TFP 25 28 40	25	28	40	9.57
	<b>PAP 2550 P10</b>	MU TFP 25 28 50	25	28	50	11.10
<b>28</b>		MU TFP 28 32 15	28	32	15	*
	<b>PAP 2820 P10</b>	MU TFP 28 32 20	28	32	20	6.64
		MU TFP 28 32 25	28	32	25	*
	<b>PAP 2830 P10</b>	MU TFP 28 32 30	28	32	30	9.00
<b>30</b>		MU TFP 30 34 10	30	34	10	*
	<b>PAP 3015 P10</b>	MU TFP 30 34 15	30	34	15	6.54
	<b>PAP 3020 P10</b>	MU TFP 30 34 20	30	34	20	6.90
	<b>PAP 3025 P10</b>	MU TFP 30 34 25	30	34	25	8.43
	<b>PAP 3030 P10</b>	MU TFP 30 34 30	30	34	30	9.40
	<b>PAP 3040 P10</b>	MU TFP 30 34 40	30	34	40	11.40
<b>32</b>		MU TFP 32 36 20	32	36	20	*
	<b>PAP 3230 P10</b>	MU TFP 32 36 30	32	36	30	10.40
	<b>PAP 3240 P10</b>	MU TFP 32 36 40	32	36	40	12.00

Gleitlager-Buchsen  
wartungsfrei, mit Stahlrücken

Palier lisse radial  
sans entretien, avec support en acier

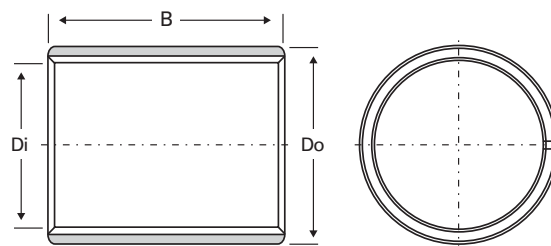

Reihen | **PAP . . P10**  
Séries

Welle Arbre Ø mm	Typ Type		Masse in mm Dimensions en mm			Preis Prix CHF
			Di	Do	B	
35	<b>PAP 3520 P10</b>	MU TFP 35 39 20	35	39	20	8.34
	<b>PAP 3530 P10</b>	MU TFP 35 39 30	35	39	30	11.20
		MU TFP 35 39 35	35	39	35	*
	<b>PAP 3540 P10</b>	MU TFP 35 39 40	35	39	40	12.90
	<b>PAP 3550 P10</b>	MU TFP 35 39 50	35	39	50	14.60
40	<b>PAP 4020 P10</b>	MU TFP 40 44 20	40	44	20	8.88
	<b>PAP 4030 P10</b>	MU TFP 40 44 30	40	44	30	11.60
	<b>PAP 4040 P10</b>	MU TFP 40 44 40	40	44	40	14.40
		MU TFP 40 44 45	40	44	45	*
	<b>PAP 4050 P10</b>	MU TFP 40 44 50	40	44	50	15.80
45		MU TFP 45 50 20	45	50	20	*
	<b>PAP 4530 P10</b>	MU TFP 45 50 30	45	50	30	16.90
	<b>PAP 4540 P10</b>	MU TFP 45 50 40	45	50	40	19.80
		MU TFP 45 50 45	45	50	45	*
	<b>PAP 4550 P10</b>	MU TFP 45 50 50	45	50	50	22.30
50	<b>PAP 5020 P10</b>	MU TFP 50 55 20	50	55	20	16.90
		MU TFP 50 55 25	50	55	25	*
	<b>PAP 5030 P10</b>	MU TFP 50 55 30	50	55	30	19.60
	<b>PAP 5040 P10</b>	MU TFP 50 55 40	50	55	40	20.80
		MU TFP 50 55 50	55	55	50	*
	<b>PAP 5060 P10</b>	MU TFP 50 55 60	55	55	60	28.30
55		MU TFP 55 60 20	55	60	20	*
		MU TFP 55 60 25	55	60	25	*
		MU TFP 55 60 30	55	60	30	*
	<b>PAP 5540 P10</b>	MU TFP 55 60 40	55	60	40	24.50
		MU TFP 55 60 50	55	60	50	*
		MU TFP 55 60 55	55	60	55	*
	<b>PAP 5560 P10</b>	MU TFP 55 60 60	55	60	60	28.80
		MU TFP 55 60 60	55	60	60	28.80
60		MU TFP 60 65 20	60	65	20	*
	<b>PAP 6030 P10</b>	MU TFP 60 65 30	60	65	30	24.50
	<b>PAP 6040 P10</b>	MU TFP 60 65 40	60	65	40	27.00
		MU TFP 60 65 50	60	65	50	*
	<b>PAP 6060 P10</b>	MU TFP 60 65 60	60	65	60	37.80
	<b>PAP 6070 P10</b>	MU TFP 60 65 70	60	65	70	40.40
		MU TFP 60 65 70	60	65	70	40.40

Gleitlager-Buchsen  
wartungsfrei, mit Stahlrücken

Palier lisse radial  
sans entretien, avec support en acier

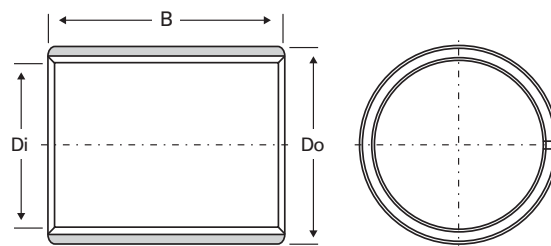

Reihen | **PAP . . P10**  
Séries

Welle Arbre Ø mm	Typ Type			Masse in mm Dimensions en mm			Preis Prix CHF
				Di	Do	B	
65	PAP	6530 P10	MU TFP 65 70 30	65	70	30	31.10
	PAP	6540 P10	MU TFP 65 70 40	65	70	40	33.90
	PAP	6550 P10	MU TFP 65 70 50	65	70	50	35.50
	PAP	6560 P10		65	70	60	42.30
	PAP	6570 P10	MU TFP 65 70 70	65	70	70	46.70
70	PAP	7040 P10	MU TFP 70 75 40	70	75	40	39.90
	PAP	7050 P10	MU TFP 70 75 50	70	75	50	41.90
			MU TFP 70 75 60	70	75	60	*
	PAP	7070 P10	MU TFP 70 75 70	70	75	70	54.40
75	PAP	7540 P10	MU TFP 75 80 40	75	80	40	40.50
	PAP	7550 P10	MU TFP 75 80 50	75	80	50	47.50
	PAP	7560 P10	MU TFP 75 80 60	75	80	60	52.20
			MU TFP 75 80 70	75	80	70	*
	PAP	7580 P10	MU TFP 75 80 80	75	80	80	72.80
80	PAP	8040 P10	MU	80	85	40	49.00
	PAP	8060 P10	MU TFP 80 85 60	80	85	60	56.80
	PAP	8080 P10	MU TFP 80 85 80	80	85	80	68.30
	PAP	80100 P10	MU TFP 80 85 100	80	85	100	83.30
85			MU TFP 85 90 30	85	90	30	*
	PAP	8560 P10	MU TFP 85 90 60	85	90	60	63.60
	PAP	85100 P10	MU TFP 85 90 100	85	90	100	93.90
90	PAP	9050 P10		90	95	50	67.20
	PAP	9060 P10	MU TFP 90 95 60	90	95	60	72.50
	PAP	90100 P10	MU TFP 90 95 100	90	95	100	99.30
95	PAP	9560 P10	MU TFP 95 100 60	95	100	60	82.00
	PAP	95100 P10	MU TFP 95 100 100	95	100	100	111.00
100	PAP	10050 P10	MU TFP 100 105 50	100	105	50	85.90
	PAP	10060 P10	MU TFP 100 105 60	100	105	60	89.20
			MU TFP 100 105 70	100	105	70	*
			MU TFP 100 105 80	100	105	80	*
			MU TFP 100 105 100	100	105	100	*
	PAP	100115 P10	MU TFP 100 105 115	100	105	115	115.00

Gleitlager-Buchsen  
wartungsfrei, mit Stahlrücken

Palier lisse radial  
sans entretien, avec support en acier

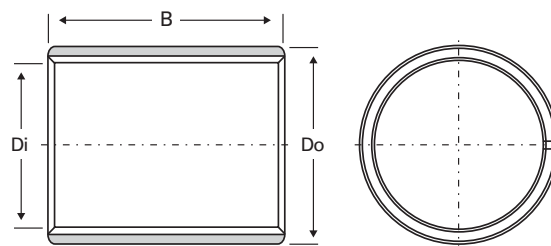

Reihen | **PAP . . P10**  
Séries

Welle Arbre Ø mm	Typ Type		Masse in mm Dimensions en mm			Preis Prix CHF
			Di	Do	B	
105	PAP 10560 P10	MU TFP 105 110 60	105	110	60	95.10
		MU TFP 105 110 100	105	110	100	*
	PAP 105115 P10	MU TFP 105 110 115	105	110	115	119.00
110	PAP 11060 P10	MU TFP 110 115 60	110	115	60	99.30
		MU TFP 110 115 100	110	115	100	*
	PAP 110115 P10	MU TFP 110 115 115	110	115	115	125.00
115	PAP 11550 P10	MU TFP 115 120 50	115	120	50	233.00
	PAP 11560 P10	MU TFP 115 120 60	115	120	60	254.00
	PAP 11570 P10	MU TFP 115 120 70	115	120	70	278.00
		MU TFP 115 120 115	115	120	115	*
120	PAP 12060 P10	MU TFP 120 125 50	120	125	50	*
		MU TFP 120 125 60	120	125	60	269.00
		MU TFP 120 125 100	120	125	100	301.00
125	PAP 125100 P10	MU TFP 125 130 60	125	130	60	*
		MU TFP 125 130 100	125	130	100	316.00
130	PAP 13060 P10	MU TFP 130 135 60	130	135	60	289.00
	PAP 130100 P10	MU TFP 130 135 100	130	135	100	327.00
135	PAP 13560 P10	MU TFP 135 140 60	135	140	60	300.00
	PAP 13580 P10	MU TFP 135 140 80	135	140	80	327.00
		MU TFP 135 140 100	135	140	100	*
140	PAP 14060 P10	MU TFP 140 145 60	140	145	60	310.00
	PAP 140100 P10	MU TFP 140 145 100	140	145	100	345.00
145		MU TFP 145 150 60	145	150	60	*
		MU TFP 145 150 100	145	150	100	*
150	PAP 15060 P10	MU TFP 150 155 60	150	155	60	329.00
	PAP 15080 P10	MU TFP 150 155 80	150	155	80	353.00
	PAP 150100 P10	MU TFP 150 155 100	150	155	100	364.00

Gleitlager-Buchsen  
wartungsfrei, mit Stahlrücken

Palier lisse radial  
sans entretien, avec support en acier

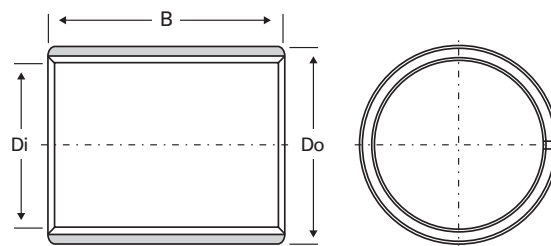

Reihen | **PAP . . P10**  
Séries

Welle Arbre Ø mm	Typ Type	Masse in mm Dimensions en mm			Preis Prix CHF	
		Di	Do	B		
<b>155</b>		MU TFP 155 160 60	155	160	60	*
		MU TFP 155 160 100	155	160	100	*
<b>160</b>		MU TFP 160 165 60	160	165	60	*
	<b>PAP 16080 P10</b>	MU TFP 160 165 80	160	165	80	365.00
	<b>PAP 160100 P10</b>	MU TFP 160 165 100	160	165	100	383.00
<b>165</b>		MU TFP 165 170 60	165	170	60	*
		MU TFP 165 170 100	165	170	100	*
<b>170</b>		MU TFP 170 175 60	170	175	60	*
		MU TFP 170 175 100	170	175	100	*
<b>175</b>		MU TFP 175 180 60	175	180	60	*
		MU TFP 175 180 100	175	180	100	*
<b>180</b>		MU TFP 180 185 60	180	185	60	*
		MU TFP 180 185 80	180	185	80	*
	<b>PAP 180100 P10</b>	MU TFP 180 185 100	180	185	100	399.00
<b>190</b>		MU TFP 190 195 60	190	195	60	*
		MU TFP 190 195 100	190	195	100	*
<b>200</b>		MU TFP 200 205 60	200	205	60	*
	<b>PAP 200100 P10</b>	MU TFP 200 205 100	200	205	100	429.00
<b>205</b>		MU TFP 205 210 60	205	210	60	*
		MU TFP 205 210 100	205	210	100	*
<b>210</b>		MU TFP 210 215 60	210	215	60	*
		MU TFP 210 215 100	210	215	100	*
<b>215</b>		MU TFP 215 220 60	215	220	60	*
		MU TFP 215 220 100	215	220	100	*
<b>220</b>		MU TFP 220 225 60	220	225	60	*
	<b>PAP 220100 P10</b>	MU TFP 220 225 100	220	225	100	440.00

Gleitlager-Buchsen  
wartungsfrei, mit Stahlrücken

Palier lisse radial  
sans entretien, avec support en acier

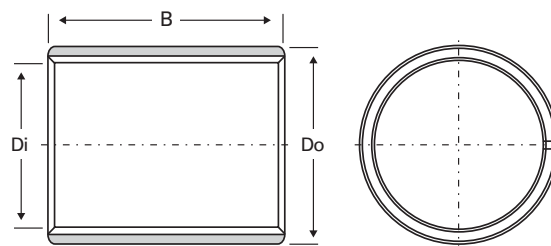

Reihen | **PAP . . P10**  
Séries

Welle Arbre Ø mm	Typ Type		Masse in mm Dimensions en mm			Preis Prix CHF
			Di	Do	B	
<b>230</b>		MU TFP 230 235 60	230	235	60	*
		MU TFP 230 235 100	230	235	100	*
<b>240</b>		MU TFP 240 245 60	240	245	60	*
		MU TFP 240 245 100	240	245	100	*
<b>250</b>	<b>PAP 250100 P10</b>	MU TFP 250 255 60	250	255	60	*
		MU TFP 250 255 100	250	255	100	488.00
<b>280</b>		MU TFP 280 285 60	280	285	60	*
		MU TFP 280 285 100	280	285	100	*
<b>300</b>	<b>PAP 300100 P10</b>	MU TFP 300 305 60	300	305	60	*
		MU TFP 300 305 100	300	305	100	530.00

Gleitlager-Buchsen  
wartungsfrei, mit Bronzerücken

Palier lisse radial  
sans entretien, avec support en bronze

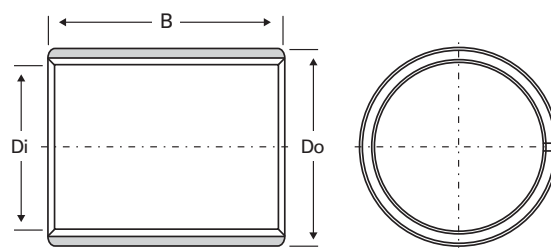

Reihen | **PAP . . P11**  
Séries

Welle Arbre Ø mm	Typ Type		Masse in mm Dimensions en mm			Preis Prix CHF
			Di	Do	B	
<b>3</b>		MU-B TFP 03 04.5 04	3	4,5	3	*
		MU-B TFP 03 04.5 04	3	4,5	4	*
		MU-B TFP 03 04.5 05	3	4,5	5	*
		MU-B TFP 03 04.5 06	3	4,5	6	*
<b>4</b>		MU-B TFP 04 05.5 03	4	5,5	3	*
		MU-B TFP 04 05.5 04	4	5,5	4	*
	<b>PAP 0406 P11</b>	MU-B TFP 04 05.5 06	4	5,5	6	1.42
		MU-B TFP 04 05.5 10	4	5,5	10	*
<b>5</b>	<b>PAP 0505 P11</b>	MU-B TFP 05 07 05	5	7	5	1.42
		MU-B TFP 05 07 08	5	7	8	*
		MU-B TFP 05 07 10	5	7	10	*
<b>6</b>		MU-B TFP 06 08 04	6	8	4	*
	<b>PAP 0606 P11</b>	MU-B TFP 06 08 06	6	8	6	1.46
		MU-B TFP 06 08 08	6	8	8	*
	<b>PAP 0610 P11</b>		6	8	10	1.49
<b>7</b>		MU-B TFP 07 09 10	7	9	10	*
<b>8</b>		MU-B TFP 08 10 06	8	10	6	*
	<b>PAP 0808 P11</b>	MU-B TFP 08 10 08	8	10	8	1.42
	<b>PAP 0810 P11</b>	MU-B TFP 08 10 10	8	10	10	1.70
	<b>PAP 0812 P11</b>	MU-B TFP 08 10 12	8	10	12	1.82
<b>10</b>	<b>PAP 1005 P11</b>		10	12	5	1.92
		MU-B TFP 10 12 08	10	12	8	*
	<b>PAP 1010 P11</b>	MU-B TFP 10 12 10	10	12	10	2.24
		MU-B TFP 10 12 12	10	12	12	*
	<b>PAP 1015 P11</b>	MU-B TFP 10 12 15	10	12	15	2.95
	<b>PAP 1020 P11</b>	MU-B TFP 10 12 20	10	12	20	3.69
<b>12</b>		MU-B TFP 12 14 08	12	14	8	*
	<b>PAP 1210 P11</b>	MU-B TFP 12 14 10	12	14	10	3.10
	<b>PAP 1212 P11</b>	MU-B TFP 12 14 12	12	14	12	3.31
	<b>PAP 1215 P11</b>	MU-B TFP 12 14 15	12	14	15	3.69
	<b>PAP 1220 P11</b>	MU-B TFP 12 14 20	12	14	20	4.21
	<b>PAP 1225 P11</b>	MU-B TFP 12 14 25	12	14	25	4.86

Gleitlager-Buchsen  
wartungsfrei, mit Bronzerücken

Palier lisse radial  
sans entretien, avec support en bronze

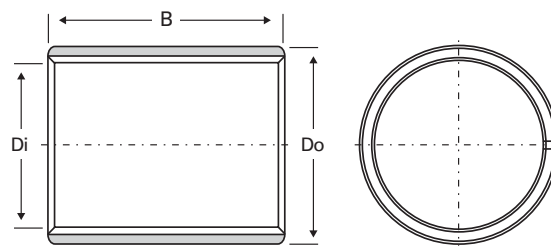

Reihen | **PAP . . P11**  
Séries

Welle Arbre Ø mm	Typ Type	Masse in mm Dimensions en mm			Preis Prix CHF
		Di	Do	B	
<b>13</b>	MU-B TFP 13 15 10	13	15	10	*
	MU-B TFP 13 15 20	13	15	20	*
<b>14</b>	MU-B TFP 14 16 05	14	16	5	*
	MU-B TFP 14 16 10	14	16	10	*
	MU-B TFP 14 16 12	14	16	12	*
	<b>PAP 1415 P11</b> MU-B TFP 14 16 15	14	16	15	3.94
	MU-B TFP 14 16 20	14	16	20	*
	MU-B TFP 14 16 25	14	16	25	*
<b>15</b>	MU-B TFP 15 17 10	15	17	10	*
	MU-B TFP 15 17 12	15	17	12	*
	<b>PAP 1515 P11</b> MU-B TFP 15 17 15	15	17	15	4.42
	MU-B TFP 15 17 20	15	17	20	*
	<b>PAP 1525 P11</b> MU-B TFP 15 17 25	15	17	25	5.08
<b>16</b>	MU-B TFP 16 18 10	16	18	10	*
	MU-B TFP 16 18 12	16	18	12	*
	<b>PAP 1615 P11</b> MU-B TFP 16 18 15	16	18	15	4.56
	MU-B TFP 16 18 20	16	18	20	*
	<b>PAP 1625 P11</b> MU-B TFP 16 18 25	16	18	25	6.61
	<b>17</b>	MU-B TFP 17 19 15	17	19	15
MU-B TFP 17 19 20		17	19	20	*
<b>18</b>	MU-B TFP 18 20 10	18	20	10	*
	<b>PAP 1815 P11</b> MU-B TFP 18 20 15	18	20	15	4.56
	MU-B TFP 18 20 20	18	20	20	*
	<b>PAP 1825 P11</b> MU-B TFP 18 20 25	18	20	25	6.81
<b>20</b>	MU-B TFP 20 22 10	20	22	10	*
	MU-B TFP 20 22 15	20	22	15	*
	MU-B TFP 20 22 20	20	22	20	*
	MU-B TFP 20 23 10	20	23	10	*
	<b>PAP 2015 P11</b> MU-B TFP 20 23 15	20	23	15	6.14
	<b>PAP 2020 P11</b> MU-B TFP 20 23 20	20	23	20	6.95
	<b>PAP 2025 P11</b> MU-B TFP 20 23 25	20	23	25	7.87
	<b>PAP 2030 P11</b> MU-B TFP 20 23 30	20	23	30	8.70

Gleitlager-Buchsen  
wartungsfrei, mit Bronzerücken

Palier lisse radial  
sans entretien, avec support en bronze

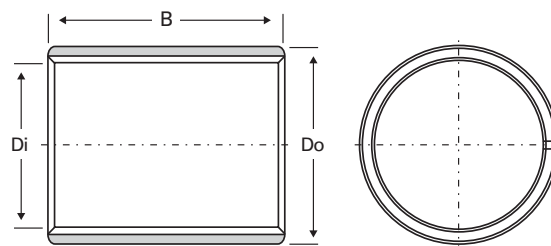

Reihen | **PAP . . P11**  
Séries

Welle Arbre Ø mm	Typ Type	Masse in mm Dimensions en mm			Preis Prix CHF		
		Di	Do	B			
<b>22</b>	<b>PAP 2215 P11</b>	MU-B TFP	22 25 15	22	25	15	6.14
	<b>PAP 2220 P11</b>	MU-B TFP	22 25 20	22	25	20	6.95
	<b>PAP 2225 P11</b>	MU-B TFP	22 25 25	22	25	25	8.53
		MU-B TFP	22 25 30	22	25	30	*
<b>24</b>	<b>PAP 2430 P11</b>	MU-B TFP	24 27 15	24	27	15	*
		MU-B TFP	24 27 20	24	27	20	*
		MU-B TFP	24 27 25	24	27	25	*
		MU-B TFP	24 27 30	24	27	30	11.80
		MU-B TFP	24 28 15	24	28	15	*
		MU-B TFP	24 28 20	24	28	20	*
		MU-B TFP	24 28 25	24	28	25	*
		MU-B TFP	24 28 30	24	28	30	*
<b>25</b>	<b>PAP 2525 P11</b> <b>PAP 2530 P11</b>	MU-B TFP	25 28 12	25	28	12	*
		MU-B TFP	25 28 15	25	28	15	*
		MU-B TFP	25 28 20	25	28	20	*
		MU-B TFP	25 28 25	25	28	25	10.60
		MU-B TFP	25 28 30	25	28	30	12.10
		MU-B TFP	25 28 40	25	28	40	*
		MU-B TFP	25 28 50	25	28	50	*
<b>28</b>	<b>PAP 2830 P11</b>	MU-B TFP	28 32 15	28	32	15	*
		MU-B TFP	28 32 20	28	32	20	*
		MU-B TFP	28 32 25	28	32	25	*
		MU-B TFP	28 32 30	28	32	30	13.20
<b>30</b>	<b>PAP 3020 P11</b> <b>PAP 3030 P11</b> <b>PAP 3040 P11</b>	MU-B TFP	30 34 10	30	34	10	*
		MU-B TFP	30 34 15	30	34	15	*
		MU-B TFP	30 34 20	30	34	20	10.10
		MU-B TFP	30 34 25	30	34	25	*
		MU-B TFP	30 34 30	30	34	30	13.50
		MU-B TFP	30 34 40	30	34	40	17.10
<b>32</b>		MU-B TFP	32 36 20	32	36	20	*
		MU-B TFP	32 36 30	32	36	30	*
		MU-B TFP	32 36 40	32	36	40	*

Gleitlager-Buchsen  
wartungsfrei, mit Bronzerücken

Palier lisse radial  
sans entretien, avec support en bronze

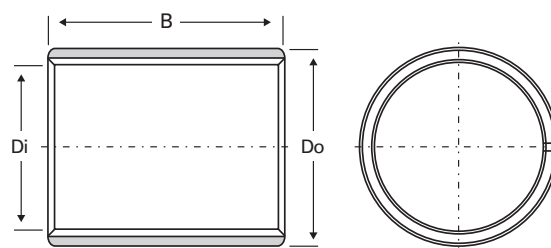

Reihen | **PAP . . P11**  
Séries

Welle Arbre Ø mm	Typ Type	Masse in mm Dimensions en mm			Preis Prix CHF	
		Di	Do	B		
<b>35</b>	<b>PAP 3520 P11</b>	MU-B TFP 35 39 20	35	39	20	12.80
	<b>PAP 3530 P11</b>	MU-B TFP 35 39 30	35	39	30	16.10
		MU-B TFP 35 39 35	35	39	35	*
		MU-B TFP 35 39 40	35	39	40	*
		MU-B TFP 35 39 50	35	39	50	*
<b>40</b>		MU-B TFP 40 44 20	40	44	20	*
		MU-B TFP 40 44 30	40	44	30	*
		MU-B TFP 40 44 40	40	44	40	*
		MU-B TFP 40 44 45	40	44	45	*
	<b>PAP 4050 P11</b>	MU-B TFP 40 44 50	40	44	50	25.90
<b>45</b>		MU-B TFP 45 50 20	45	50	20	*
		MU-B TFP 45 50 30	45	50	30	*
		MU-B TFP 45 50 40	45	50	40	*
		MU-B TFP 45 50 45	45	50	45	*
	<b>PAP 4550 P11</b>	MU-B TFP 45 50 50	45	50	50	37.70
<b>50</b>		MU-B TFP 50 55 20	50	55	20	*
		MU-B TFP 50 55 25	50	55	25	*
	<b>PAP 5030 P11</b>	MU-B TFP 50 55 30	50	55	30	34.80
	<b>PAP 5040 P11</b>	MU-B TFP 50 55 40	50	55	40	37.70
	<b>PAP 5060 P11</b>	MU-B TFP 50 55 50	50	55	50	*
<b>55</b>		MU-B TFP 55 60 20	55	60	20	*
		MU-B TFP 55 60 25	55	60	25	*
		MU-B TFP 55 60 30	55	60	30	*
	<b>PAP 5540 P11</b>	MU-B TFP 55 60 40	55	60	40	38.50
		MU-B TFP 55 60 50	55	60	50	*
		MU-B TFP 55 60 55	55	60	55	*
		MU-B TFP 55 60 60	55	60	60	*
<b>60</b>		MU-B TFP 60 65 20	60	65	20	*
		MU-B TFP 60 65 30	60	65	30	*
	<b>PAP 6040 P11</b>	MU-B TFP 60 65 40	60	65	40	44.00
	<b>PAP 6050 P11</b>	MU-B TFP 60 65 50	60	65	50	53.40
	<b>PAP 6060 P11</b>	MU-B TFP 60 65 60	60	65	60	62.40
	<b>PAP 6070 P11</b>	MU-B TFP 60 65 70	60	65	70	71.10

Gleitlager-Buchsen  
wartungsfrei, mit Bronzerücken

Palier lisse radial  
sans entretien, avec support en bronze

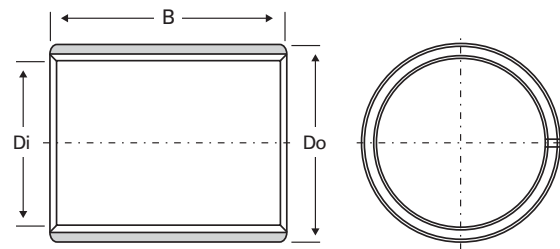

Reihen | **PAP . . P11**  
Séries

Welle Arbre Ø mm	Typ Type		Masse in mm Dimensions en mm			Preis Prix CHF	
			Di	Do	B		
<b>65</b>		MU-B TFP 65 70 30	65	70	30	*	
		MU-B TFP 65 70 40	65	70	40	*	
		MU-B TFP 65 70 50	65	70	50	*	
		MU-B TFP 65 70 70	65	70	70	*	
<b>70</b>	<b>PAP</b>	<b>7050 P11</b>	MU-B TFP 70 75 40	70	75	40	*
			MU-B TFP 70 75 70	70	75	70	69.00
			MU-B TFP 70 75 60	70	75	60	*
	<b>PAP</b>	<b>7070 P11</b>	MU-B TFP 70 75 70	70	75	70	87.20
<b>75</b>		MU-B TFP 75 80 40	75	80	40	*	
		MU-B TFP 75 80 50	75	80	50	*	
		MU-B TFP 75 80 60	75	80	60	*	
		MU-B TFP 75 80 70	75	80	70	*	
		MU-B TFP 75 80 80	75	80	80	*	
<b>80</b>	<b>PAP</b>	<b>8060 P11</b>	MU-B TFP 80 85 40	80	85	40	*
			MU-B TFP 80 85 60	80	85	60	98.90
			MU-B TFP 80 85 80	80	85	80	*
	<b>PAP</b>	<b>80100 P11</b>	MU-B TFP 80 85 100	80	85	100	140.00
<b>85</b>		MU-B TFP 85 90 30	85	90	30	*	
		MU-B TFP 85 90 60	85	90	60	*	
		MU-B TFP 85 90 100	85	90	100	*	
<b>90</b>	<b>PAP</b>	<b>9060 P11</b>	MU-B TFP 90 95 60	90	95	60	125.00
	<b>PAP</b>	<b>90100 P11</b>	MU-B TFP 90 95 100	90	95	100	168.00
<b>95</b>	<b>PAP</b>	<b>9560 P11</b>	MU-B TFP 95 100 60	95	100	60	135.00
	<b>PAP</b>	<b>95100 P11</b>	MU-B TFP 95 100 100	95	100	100	*
<b>100</b>	<b>PAP</b>	<b>10060 P11</b>	MU-B TFP 100 105 50	100	105	50	*
			MU-B TFP 100 105 60	100	105	60	145.00
			MU-B TFP 100 105 70	100	105	70	*
			MU-B TFP 100 105 80	100	105	80	*
			MU-B TFP 100 105 100	100	105	100	*
	<b>PAP</b>	<b>100115 P11</b>	MU-B TFP 100 105 115	100	105	115	188.00
<b>105</b>		MU-B TFP 105 110 60	105	110	60	*	
		MU-B TFP 105 110 100	105	110	100	*	
		MU-B TFP 105 110 115	105	110	115	*	

Gleitlager-Buchsen  
wartungsfrei, mit Bronzerücken

Palier lisse radial  
sans entretien, avec support en bronze

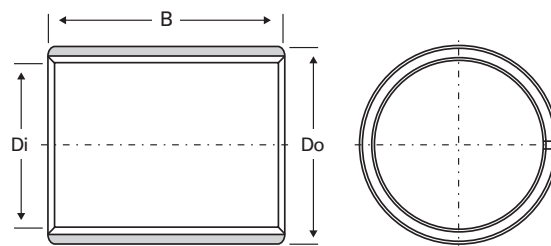

Reihen | **PAP . . P11**  
Séries

Welle Arbre Ø mm	Typ Type	Masse in mm Dimensions en mm			Preis Prix CHF
		Di	Do	B	
<b>110</b>	MU-B TFP 110 115 60	110	115	60	*
	MU-B TFP 110 115 100	110	115	100	*
	MU-B TFP 110 115 115	110	115	115	*
<b>115</b>	MU-B TFP 115 120 50	115	120	50	*
	MU-B TFP 115 120 60	115	120	60	*
	MU-B TFP 115 120 70	115	120	70	*
	MU-B TFP 115 120 115	115	120	115	*
<b>120</b>	MU-B TFP 120 125 50	120	125	50	*
	MU-B TFP 120 125 60	120	125	60	*
	MU-B TFP 120 125 100	120	125	100	*
<b>125</b>	MU-B TFP 125 130 60	125	130	60	*
	MU-B TFP 125 130 100	125	130	100	*
<b>130</b>	MU-B TFP 130 135 60	130	135	60	*
	MU-B TFP 130 135 100	130	135	100	*
<b>135</b>	MU-B TFP 135 140 60	135	140	60	*
	MU-B TFP 135 140 80	135	140	80	*
	MU-B TFP 135 140 100	135	140	100	*
<b>140</b>	MU-B TFP 140 145 60	140	145	60	*
	MU-B TFP 140 145 100	140	145	100	*
<b>145</b>	MU-B TFP 145 150 60	145	150	60	*
	MU-B TFP 145 150 100	145	150	100	*
<b>150</b>	MU-B TFP 150 155 60	150	155	60	*
	MU-B TFP 150 155 80	150	155	80	*
	MU-B TFP 150 155 100	150	155	100	*
<b>155</b>	MU-B TFP 155 160 60	155	160	60	*
	MU-B TFP 155 160 100	155	160	100	*
<b>160</b>	MU-B TFP 160 165 60	160	165	60	*
	MU-B TFP 160 165 80	160	165	80	*
	MU-B TFP 160 165 100	160	165	100	*
<b>165</b>	MU-B TFP 165 170 60	165	170	60	*
	MU-B TFP 165 170 100	165	170	100	*

Gleitlager-Buchsen  
wartungsfrei, mit Bronzerücken

Palier lisse radial  
sans entretien, avec support en bronze

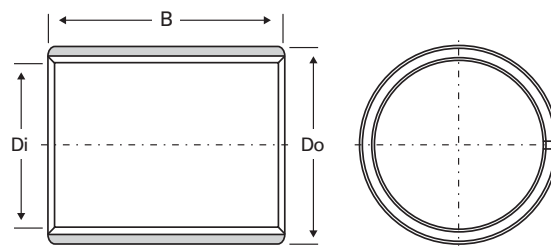

Reihen | **PAP . . P11**  
Séries

Welle Arbre Ø mm	Typ Type	Masse in mm Dimensions en mm			Preis Prix CHF
		Di	Do	B	
<b>170</b>	MU-B TFP	170	175	60	*
	MU-B TFP	170	175	100	*
<b>175</b>	MU-B TFP	175	180	60	*
	MU-B TFP	175	180	100	*
<b>180</b>	MU-B TFP	180	185	60	*
	MU-B TFP	180	185	80	*
	MU-B TFP	180	185	100	*
<b>190</b>	MU-B TFP	190	195	60	*
	MU-B TFP	190	195	100	*
<b>200</b>	MU-B TFP	200	205	60	*
	MU-B TFP	200	205	100	*
<b>205</b>	MU-B TFP	205	210	60	*
	MU-B TFP	205	210	100	*
<b>210</b>	MU-B TFP	210	215	60	*
	MU-B TFP	210	215	100	*
<b>215</b>	MU-B TFP	215	220	60	*
	MU-B TFP	215	220	100	*
<b>220</b>	MU-B TFP	220	225	60	*
	MU-B TFP	220	225	100	*
<b>230</b>	MU-B TFP	230	235	60	*
	MU-B TFP	230	235	100	*
<b>240</b>	MU-B TFP	240	245	60	*
	MU-B TFP	240	245	100	*
<b>250</b>	MU-B TFP	250	255	60	*
	MU-B TFP	250	255	100	*
<b>280</b>	MU-B TFP	280	285	60	*
	MU-B TFP	280	285	100	*
<b>300</b>	MU-B TFP	240	245	60	*
	MU-B TFP	240	245	100	*

Gleitlager-Bundbuchsen  
wartungsfrei, mit Stahlrücken

Palier lisse radial à collerete  
sans entretien, avec support en acier

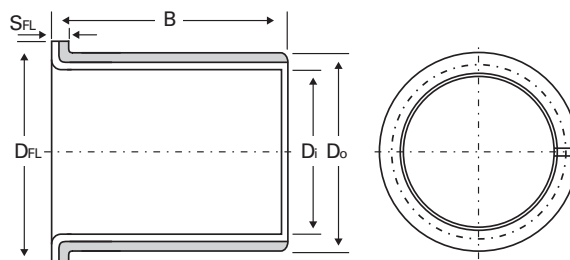

Reihen | **PAF . . P10**  
Séries

Welle Arbre Ø mm	Typ Type			Masse in mm Dimensions en mm					Preis Prix CHF
				D <sub>i</sub>	D <sub>o</sub>	D <sub>FL</sub>	B	S <sub>FL</sub>	
6	<b>PAF 06040 P10</b>	MU TFF	06 08 0	6	8	12	4	1	2.31
	<b>PAF 06070 P10</b>	MU TFF	06 08 07	6	8	12	7	1	2.43
	<b>PAF 06080 P10</b>	MU TFF	06 08 08	6	8	12	8	1	2.46
8	<b>PAF 08055 P10</b>	MU TFF	08 10 05.5	8	10	15	5,5	1	2.53
	<b>PAF 08075 P10</b>	MU TFF	08 10 07.5	8	10	15	7,5	1	2.53
	<b>PAF 08095 P10</b>	MU TFF	08 10 09.5	8	10	15	9,5	1	2.53
10	<b>PAF 10070 P10</b>	MU TFF	10 12 07	10	12	18	7	1	3.31
	<b>PAF 10090 P10</b>	MU TFF	10 12 09	10	12	18	9	1	3.42
	<b>PAF 10120 P10</b>	MU TFF	10 12 12	10	12	18	12	1	3.57
	<b>PAF 10170 P10</b>	MU TFF	10 12 17	10	12	18	17	1	4.96
12	<b>PAF 12070 P10</b>	MU TFF	12 14 07	12	14	20	7	1	4.14
	<b>PAF 12090 P10</b>	MU TFF	12 14 09	12	14	20	9	1	4.27
	<b>PAF 12120 P10</b>	MU TFF	12 14 12	12	14	20	12	1	4.72
	<b>PAF 12170 P10</b>	MU TFF	12 14 17	12	14	20	17	1	5.38
14	<b>PAF 14120 P10</b>	MU TFF	14 16 12	14	16	22	12	1	4.72
	<b>PAF 14170 P10</b>	MU TFF	14 16 17	14	16	22	17	1	5.46
15	<b>PAF 15090 P10</b>	MU TFF	15 17 09	15	17	23	9	1	5.46
	<b>PAF 15120 P10</b>	MU TFF	15 17 12	15	17	23	12	1	5.60
	<b>PAF 15170 P10</b>	MU TFF	15 17 17	15	17	23	17	1	6.02

Gleitlager-Bundbuchsen  
wartungsfrei, mit Stahlrücken

Palier lisse radial à collerete  
sans entretien, avec support en acier

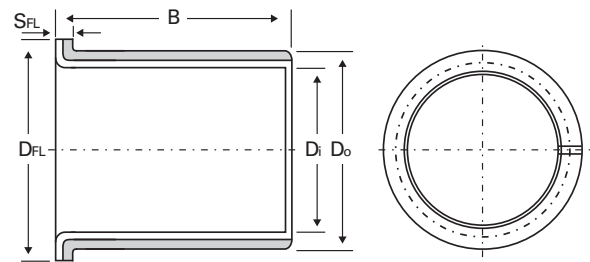

Reihen | **PAF . . P10**  
Séries

Welle Arbre Ø mm	Typ Type		Masse in mm Dimensions en mm					Preis Prix CHF
			D <sub>i</sub>	D <sub>o</sub>	D <sub>FL</sub>	B	S <sub>FL</sub>	
16	<b>PAF 16120 P10</b>	MU TFF 16 18 12	16	18	24	12	1	5.70
	<b>PAF 16170 P10</b>	MU TFF 16 18 17	16	18	24	17	1	6.12
18	<b>PAF 18120 P10</b>	MU TFF 18 20 12	18	20	26	12	1	6.95
	<b>PAF 18170 P10</b>	MU TFF 18 20 17	18	20	26	17	1	7.28
	<b>PAF 18220 P10</b>	MU TFF 18 20 22	18	20	26	22	1	7.63
20	<b>PAF 20115 P10</b>	MU TFF 20 23 11.5	20	23	30	11,5	1,5	8.43
	<b>PAF 20165 P10</b>	MU TFF 20 23 16.5	20	23	30	16,5	1,5	8.76
	<b>PAF 20215 P10</b>	MU TFF 20 23 21.5	20	23	30	21,5	1,5	9.12
25	<b>PAF 25115 P10</b>	MU TFF 25 28 11.5	25	28	35	11,5	1,5	11.60
	<b>PAF 25165 P10</b>	MU TFF 25 28 16.5	25	28	35	16,5	1,5	12.00
	<b>PAF 25215 P10</b>	MU TFF 25 28 21.5	25	28	35	21,5	1,5	12.50
30	<b>PAF 30160 P10</b>	MU TFF 30 34 16	30	34	42	16	2	14.20
	<b>PAF 30260 P10</b>	MU TFF 30 34 26	30	34	42	26	2	15.20
35	<b>PAF 35160 P10</b>	MU TFF 35 39 16	35	39	47	16	2	15.10
	<b>PAF 35260 P10</b>	MU TFF 35 39 26	35	39	47	26	2	16.60
40		MU TFF 40 44 16	40	44	53	16	2	*
	<b>PAF 40260 P10</b>	MU TFF 40 44 26	40	44	53	26	2	18.00
45		MU TFF 45 50 16	45	50	58	16	2	*
		MU TFF 45 50 26	45	50	58	26	2	*

Gleitlager-Bundbuchsen  
wartungsfrei, mit Bronzerücken

Palier lisse radial à collerete  
sans entretien, avec support en bronze

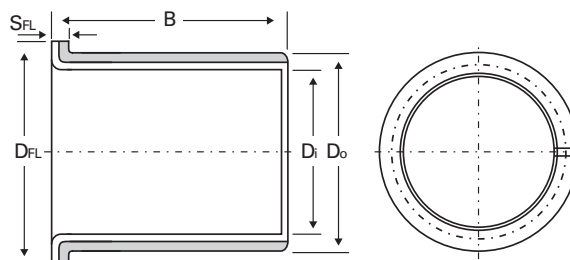

Reihen | **PAF . . P11**  
Séries

Welle Arbre Ø mm	Typ Type	Masse in mm Dimensions en mm					Preis Prix CHF
		D <sub>i</sub>	D <sub>o</sub>	D <sub>FL</sub>	B	S <sub>FL</sub>	
6	PAF 06080 P11	6	8	12	8	1	*
8	PAF 08055 P11	8	10	15	5,5	1	*
	PAF 08095 P11	8	10	15	9,5	1	*
10	PAF 10070 P11	10	12	18	7	1	*
	PAF 10120 P11	10	12	18	12	1	*
	PAF 10170 P11	10	12	18	17	1	*
12	PAF 12070 P11	12	14	20	7	1	*
	PAF 12090 P11	12	14	20	9	1	*
	PAF 12120 P11	12	14	20	12	1	*
15	PAF 15120 P11	15	17	23	12	1	*
	PAF 15170 P11	15	17	23	17	1	*
16	PAF 16120 P11	16	18	24	12	1	*
18	PAF 18100 P11	18	20	26	10	1	*
	PAF 18220 P11	18	20	26	22	1	*
20	PAF 20115 P11	20	23	30	11,5	1,5	*
	PAF 20165 P11	20	23	30	16,5	1,5	*
25	PAF 25215 P11	25	28	35	21,5	1,5	*
30	PAF 30160 P11	30	34	42	16	2	*
	PAF 30260 P11	30	34	42	26	2	*
35	PAF 35260 P11	35	39	47	26	2	*
40	PAF 40260 P11	40	44	53	26	2	*

Weitere Dimensionen und Ausführungen auf Anfrage lieferbar.  
Autres dimensions et exécutions livrable sur demande.

Gleitlager-Anlaufscheiben  
wartungsfrei, mit Stahlrücken

Palier lisse axial  
sans entretien, avec support en acier

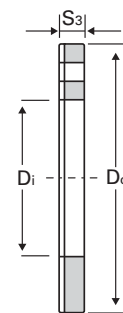

Reihen | **PAW . . P10**  
Séries

Welle Arbre Ø mm	Typ Type	Masse in mm Dimensions en mm			Preis Prix CHF
		$D_i$	$D_o$	$S_3$	
<b>PAW 10 P10</b>	MU TFW 10/15	10	20	1,5	3.50
<b>PAW 12 P10</b>	MU TFW 12/15	12	24	1,5	3.59
<b>PAW 14 P10</b>	MU TFW 14/15	14	26	1,5	3.78
<b>PAW 16 P10</b>	MU TFW 16/15	16	30	1,5	4.27
<b>PAW 18 P10</b>	MU TFW 18/15	18	32	1,5	4.56
<b>PAW 20 P10</b>	MU TFW 20/15	20	36	1,5	5.51
<b>PAW 22 P10</b>	MU TFW 22/15	22	38	1,5	5.70
<b>PAW 24 P10</b>	MU TFW 24/15	24	42	1,5	*
<b>PAW 26 P10</b>	MU TFW 26/15	26	44	1,5	7.87
<b>PAW 28 P10</b>	MU TFW 28/15	28	48	1,5	8.46
<b>PAW 32 P10</b>	MU TFW 32/15	32	54	1,5	10.40
<b>PAW 38 P10</b>	MU TFW 38/15	38	62	1,5	12.80
<b>PAW 42 P10</b>	MU TFW 42/15	42	66	1,5	13.50
<b>PAW 48 P10</b>	MU TFW 48/15	48	74	2	19.00
<b>PAW 52 P10</b>	MU TFW 52/15	52	78	2	21.00
<b>PAW 62 P10</b>	MU TFW 62/15	62	90	2	30.60

Gleitlager-Streifen  
wartungsfrei, mit Stahlrücken

Palier lisse en bande  
sans entretien, avec support en acier

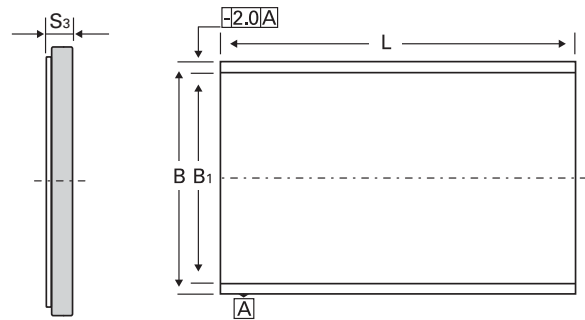

Reihen | **PAS . . P10**  
Séries

Typ Type		Masse in mm Dimensions en mm				Preis Prix CHF
		S <sub>3</sub>	B	B <sub>1</sub>	L	
<b>PAS 05180 P10</b>		0,5	180	168	500	218.00
	MU TFS 07150	0,75	150		500	*
<b>PAS 07250 P10</b>		0,75	250	238	500	309.00
	MU TFS 10200	0,95	215		500	*
<b>PAS 10250 P10</b>		1	250	238	500	243.00
	MU TFS 15240	1,5	245		500	*
<b>PAS 15250 P10</b>		1,5	250	238	500	251.00
	MU TFS 20240	2	245		500	*
<b>PAS 20250 P10</b>		2	250	238	500	289.00
	MU TFS 25240	2,5	245		500	*
<b>PAS 25250 P10</b>		2,5	250	238	500	316.00
	MU TFS 30240	3	245		500	*
<b>PAS 30250 P10</b>		3,6	250	238	500	348.00

Gleitlager-Streifen  
wartungsfrei, mit Bronzerücken

Palier lisse en bande  
sans entretien, avec support en acier

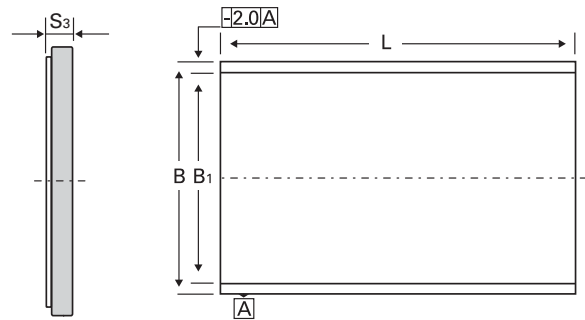

Reihen | **PAS . . P11**  
Séries

Typ Type		Masse in mm Dimensions en mm			Preis Prix CHF	
		S <sub>3</sub>	B	B <sub>1</sub>		L
<b>PAS 10160 P11</b>	MU-B TFS 07150	0,75	150		500	*
	MU-B TFS 10200	0,95	215		500	*
		1	160	148	500	298.00
<b>PAS 15180 P11</b>		1,5	180	168	500	347.00
<b>PAS 20180 P11</b>	MU-B TFS 15240	1,5	245		500	*
		2	180	168	500	357.00
<b>PAS 25180 P11</b>	MU-B TFS 20240	2	245		500	*
	MU-B TFS 25240	2,5	180	168	500	400.00
		2,5	245		500	*
	MU-B TFS 30240	3	245		500	*

Gleitlager-Buchsen wartungsarm,  
mit Schmieraschen, mit Stahlrücken

Palier lisse radial à entretien  
réduit, avec alvéoles de graissage,  
avec support en acier

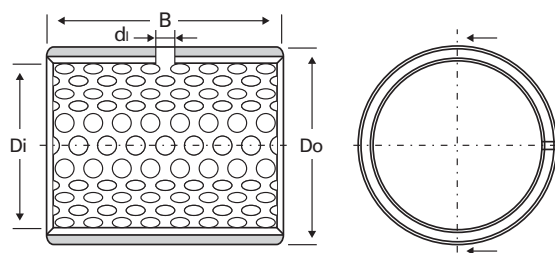

Reihen | **PAP . . P20**  
Séries

Welle Arbre Ø mm	Typ Type		Masse in mm Dimensions en mm			Preis Prix CHF
			Di	Do	B	
8	<b>PAP 0808 P20</b>	MX TFP 08 10 08	8	10	8	1.01
	<b>PAP 0810 P20</b>	MX TFP 08 10 10	8	10	10	1.30
	<b>PAP 0812 P20</b>	MX TFP 08 10 12	8	10	12	1.37
10	<b>PAP 1008 P20</b>		10	12	8	1.40
	<b>PAP 1010 P20</b>	MX TFP 10 12 10	10	12	10	1.66
		MX TFP 10 12 12	10	12	12	*
	<b>PAP 1015 P20</b>	MX TFP 10 12 15	10	12	15	2.20
		MX TFP 10 12 20	10	12	20	*
12	<b>PAP 1210 P20</b>	MX TFP 12 14 10	12	14	10	2.24
	<b>PAP 1212 P20</b>	MX TFP 12 14 12	12	14	12	2.39
	<b>PAP 1215 P20</b>	MX TFP 12 14 15	12	14	15	2.74
	<b>PAP 1220 P20</b>	MX TFP 12 14 20	12	14	20	3.02
		MX TFP 12 14 25	12	14	25	*
14		MX TFP 14 16 15	14	16	15	*
	<b>PAP 1420 P20</b>	MX TFP 14 16 20	14	16	20	3.10
		MX TFP 14 16 25	14	16	25	*
15	<b>PAP 1510 P20</b>	MX TFP 15 17 10	15	17	10	2.81
		MX TFP 15 17 12	15	17	12	*
	<b>PAP 1515 P20</b>	MX TFP 15 17 15	15	17	15	3.16
		MX TFP 15 17 20	15	17	20	*
	<b>PAP 1525 P20</b>		15	17	25	4.13
16	<b>PAP 1612 P20</b>		16	18	12	3.07
	<b>PAP 1615 P20</b>	MX TFP 16 18 15	16	18	15	3.21
	<b>PAP 1620 P20</b>	MX TFP 16 18 20	16	18	20	3.80
		MX TFP 16 18 25	16	18	25	*
18	<b>PAP 1815 P20</b>	MX TFP 18 20 15	18	20	15	3.68
	<b>PAP 1820 P20</b>	MX TFP 18 20 20	18	20	20	4.02
		MX TFP 18 20 25	18	20	25	*
20		MX TFP 20 23 10	20	23	10	*
	<b>PAP 2015 P20</b>	MX TFP 20 23 15	20	23	15	3.85
	<b>PAP 2020 P20</b>	MX TFP 20 23 20	20	23	20	4.20
	<b>PAP 2025 P20</b>	MX TFP 20 23 25	20	23	25	5.01
	<b>PAP 2030 P20</b>	MX TFP 20 23 30	20	23	30	5.60

Gleitlager-Buchsen wartungsarm,  
mit Schmieraschen, mit Stahlrücken

Palier lisse radial à entretien  
réduit, avec alvéoles de graissage,  
avec support en acier

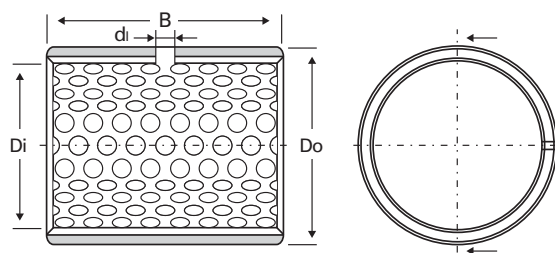

Reihen | **PAP . . P20**  
Séries

Welle Arbre Ø mm	Typ Type		Masse in mm Dimensions en mm			Preis Prix CHF
			Di	Do	B	
<b>22</b>	<b>PAP 2220 P20</b>	MX TFP 22 25 15	22	25	15	*
		MX TFP 22 25 20	22	25	20	4.65
		MX TFP 22 25 25	22	25	25	*
		MX TFP 22 25 30	22	25	30	*
<b>24</b>		MX TFP 24 27 15	24	27	15	*
		MX TFP 24 27 20	24	27	20	*
		MX TFP 24 27 25	24	27	25	*
		MX TFP 24 27 30	24	27	30	*
<b>25</b>	<b>PAP 2515 P20</b>	MX TFP 25 28 15	25	28	15	5.22
	<b>PAP 2520 P20</b>	MX TFP 25 28 20	25	28	20	5.74
	<b>PAP 2525 P20</b>	MX TFP 25 28 25	25	28	25	6.54
	<b>PAP 2530 P20</b>	MX TFP 25 28 30	25	28	30	7.39
<b>28</b>		MX TFP 28 32 30	28	32	30	*
		MX TFP 28 32 20	28	32	20	*
		MX TFP 28 32 25	28	32	25	*
		<b>PAP 2830 P20</b>	MX TFP 28 32 30	28	32	30
<b>30</b>	<b>PAP 3020 P20</b>	MX TFP 30 34 20	30	34	20	6.14
	<b>PAP 3025 P20</b>		30	34		7.59
	<b>PAP 3030 P20</b>	MX TFP 30 34 30	30	34	30	8.53
	<b>PAP 3040 P20</b>	MX TFP 30 34 40	30	34	40	10.40
<b>32</b>	<b>PAP 3230 P20</b>	MX TFP 32 36 20	32	36	20	*
		MX TFP 32 36 30	32	36	30	9.21
		MX TFP 32 36 35	32	36	35	*
		MX TFP 32 36 40	32	36	40	*
<b>35</b>	<b>PAP 3520 P20</b>	MX TFP 35 39 20	35	39	20	7.56
	<b>PAP 3530 P20</b>	MX TFP 35 39 30	35	39	30	9.99
		MX TFP 35 39 35	35	39	35	*
	<b>PAP 3550 P20</b>	MX TFP 35 39 50	35	39	50	13.30
<b>36</b>		MX TFP 36 40 35	36	40	35	*
<b>37</b>		MX TFP 37 40 20	37	40	20	*
<b>40</b>	<b>PAP 4020 P20</b>	MX TFP 40 44 20	40	44	20	7.99
	<b>PAP 4030 P20</b>	MX TFP 40 44 30	40	44	30	10.60
	<b>PAP 4040 P20</b>	MX TFP 40 44 40	40	44	40	12.90
	<b>PAP 4050 P20</b>	MX TFP 40 44 50	40	44	50	14.50

\* auf Anfrage  
sur demande

Gleitlager-Buchsen wartungsarm,  
mit Schmieraschen, mit Stahlrücken

Palier lisse radial à entretien  
réduit, avec alvéoles de graissage,  
avec support en acier

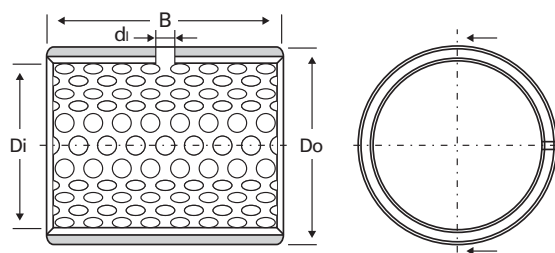

Reihen | **PAP . . P20**  
Séries

Welle Arbre Ø mm	Typ Type		Masse in mm Dimensions en mm			Preis Prix CHF
			Di	Do	B	
45	PAP 4540 P20	MX TFP 45 50 20	45	50	20	*
		MX TFP 45 50 30	45	50	30	*
		MX TFP 45 50 40	45	50	40	16.20
		MX TFP 45 50 45	45	50	45	*
		MX TFP 45 50 50	45	50	50	20.10
50	PAP 5025 P20		50	55	25	16.50
	PAP 5040 P20	MX TFP 50 55 40	50	55	40	19.00
	PAP 5060 P20	MX TFP 50 55 50	50	55	50	*
55	PAP 5540 P20	MX TFP 55 60 20	55	60	20	*
		MX TFP 55 60 25	55	60	25	*
		MX TFP 55 60 30	55	60	30	*
		MX TFP 55 60 40	55	60	40	22.30
		MX TFP 55 60 50	55	60	50	*
		MX TFP 55 60 60	55	60	60	*
60	PAP 6030 P20	MX TFP 60 65 30	60	65	30	22.30
	PAP 6040 P20	MX TFP 60 65 40	60	65	40	24.50
	PAP 6060 P20	MX TFP 60 65 60	60	65	60	34.50
		MX TFP 60 65 70	60	65	70	*
70	PAP 7040 P20	MX TFP 70 75 40	70	75	40	36.40
	PAP 7050 P20	MX TFP 70 75 50	70	75	50	38.10
	PAP 7070 P20	MX TFP 70 75 65	70	75	65	*
		MX TFP 70 75 70	70	75	70	49.30
		MX TFP 70 75 80	70	75	80	*
75	PAP 7540 P20	MX TFP 75 80 40	75	80	40	36.50
	PAP 7580 P20	MX TFP 75 80 60	75	80	60	*
		MX TFP 75 80 80	75	80	80	66.10
80	PAP 8040 P20	MX TFP 80 85 40	80	85	40	44.60
		MX TFP 80 85 50	80	85	50	*
	PAP 8055 P20	MX TFP 80 85 55	80	85	55	50.10
	PAP 8060 P20	MX TFP 80 85 60	80	85	60	51.60
	PAP 8080 P20	MX TFP 80 85 80	80	85	80	61.50
		MX TFP 80 85 100	80	85	100	*

Gleitlager-Buchsen wartungsarm,  
mit Schmiertaschen, mit Stahlrücken

Palier lisse radial à entretien  
réduit, avec alvéoles de graissage,  
avec support en acier

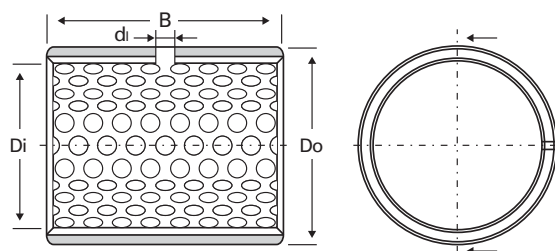

Reihen | **PAP . . P20**  
Séries

Welle Arbre Ø mm	Typ Type		Masse in mm Dimensions en mm			Preis Prix CHF
			Di	Do	B	
<b>85</b>		MX TFP 85 90 30	85	90	30	*
		MX TFP 85 90	85	90	40	*
		MX TFP 85 90 60	85	90	60	*
		MX TFP 85 90 80	85	90	80	*
		MX TFP 85 90 100	85	90	100	*
<b>90</b>	<b>PAP 9060 P20</b>	MX TFP 90 95 40	90	95	40	*
		MX TFP 90 95 60	90	95	60	65.60
		MX TFP 90 95 80	90	95	80	*
		MX TFP 90 95 90	90	95	90	*
		MX TFP 90 95 100	90	95	100	*
<b>95</b>		MX TFP 95 100 60	95	100	60	*
		MX TFP 95 100 100	95	100	100	*
<b>100</b>	<b>PAP 10050 P20 PAP 10060 P20</b>	MX TFP 100 105 50	100	105	50	75.60
		MX TFP 100 105 60	100	105	60	81.00
		MX TFP 100 105 80	100	105	80	*
		MX TFP 100 105 95	100	105	95	*
		MX TFP 100 105 115	100	105	115	*
<b>105</b>		MX TFP 105 115 60	105	115	60	*
		MX TFP 105 115 100	105	115	100	*
		MX TFP 105 115 115	105	115	115	*
<b>110</b>		MX TFP 110 115 60	110	115	60	*
		MX TFP 110 115 100	110	115	100	*
		MX TFP 110 115 115	110	115	115	*
<b>115</b>		MX TFP 115 120 50	115	120	50	*
		MX TFP 115 120 70	115	120	70	*
<b>120</b>		MX TFP 120 125 60	120	125	60	*
		MX TFP 120 125 100	120	125	100	*
		MX TFP 120 125 110	120	125	110	*
<b>125</b>		MX TFP 125 130 60	125	130	60	*
		MX TFP 125 130 100	125	130	100	*
		MX TFP 125 130 110	125	130	110	*

Gleitlager-Buchsen wartungsarm,  
mit Schmieraschen, mit Stahlrücken

Palier lisse radial à entretien  
réduit, avec alvéoles de graissage,  
avec support en acier

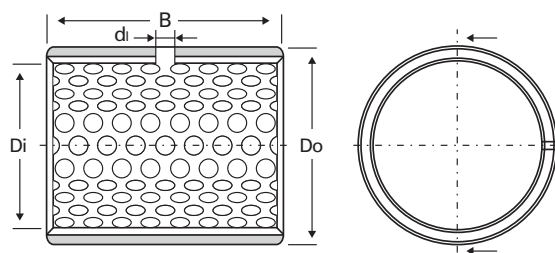

Reihen | **PAP . . P20**  
Séries

Welle Arbre Ø mm	Typ Type		Masse in mm Dimensions en mm			Preis Prix CHF
			Di	Do	B	
<b>130</b>		MX TFP 130 135 50	130	135	50	*
		MX TFP 130 135 60	130	135	60	*
		MX TFP 130 135 80	130	135	80	*
		MX TFP 130 135 100	130	135	100	*
<b>135</b>		MX TFP 135 140 60	135	140	60	*
		MX TFP 135 140 80	135	140	80	*
<b>140</b>		MX TFP 140 145 50	140	145	50	*
		MX TFP 140 145 60	140	145	60	*
		MX TFP 140 145 80	140	145	80	*
		MX TFP 140 145 100	140	145	100	*
<b>150</b>		MX TFP 150 155 50	150	155	50	*
		MX TFP 150 155 60	150	155	60	*
		MX TFP 150 155 80	150	155	80	*
		MX TFP 150 155 100	150	155	100	*
<b>160</b>		MX TFP 160 165 50	160	165	50	*
		MX TFP 160 165 60	160	165	60	*
		MX TFP 160 165 80	160	165	80	*
		MX TFP 160 165 100	160	165	100	*
<b>170</b>		MX TFP 170 175 50	170	175	50	*
		MX TFP 170 175 60	170	175	60	*
		MX TFP 170 175 80	170	175	80	*
		MX TFP 170 175 100	170	175	100	*
<b>180</b>		MX TFP 180 185 50	180	185	50	*
		MX TFP 180 185 60	180	185	60	*
		MX TFP 180 185 80	180	185	80	*
		MX TFP 180 185 100	180	185	100	*
<b>190</b>		MX TFP 190 195 50	190	195	50	*
		MX TFP 190 195 60	190	195	60	*
		MX TFP 190 195 80	190	195	80	*
		MX TFP 190 195 100	190	195	100	*
		MX TFP 190 195 120	190	195	120	*

Gleitlager-Buchsen wartungsarm,  
mit Schmier Taschen, mit Stahlrücken

Palier lisse radial à entretien  
réduit, avec alvéoles de graissage,  
avec support en acier

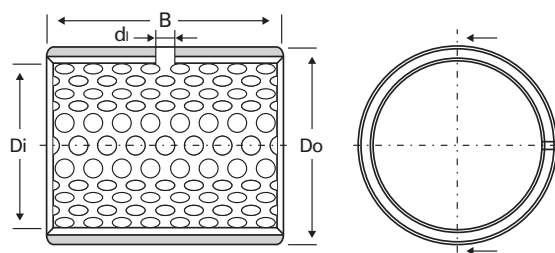

Reihen | **PAP . . P20**  
Séries

Welle Arbre Ø mm	Typ Type	Masse in mm Dimensions en mm			Preis Prix CHF
		Di	Do	B	
<b>200</b>	MX TFP 200 205 50	200	205	50	*
	MX TFP 200 205 60	200	205	60	*
	MX TFP 200 205 80	200	205	80	*
	MX TFP 200 205 100	200	205	100	*
	MX TFP 200 205 120	200	205	120	*
<b>220</b>	MX TFP 220 225 50	220	225	50	*
	MX TFP 220 225 60	220	225	60	*
	MX TFP 220 225 80	220	225	80	*
	MX TFP 220 225 100	220	225	100	*
	MX TFP 220 225 120	220	225	120	*
<b>240</b>	MX TFP 240 245 50	240	245	50	*
	MX TFP 240 245 60	240	245	60	*
	MX TFP 240 245 80	240	245	80	*
	MX TFP 240 245 100	240	245	100	*
	MX TFP 240 245 120	240	245	120	*
<b>250</b>	MX TFP 250 255 50	250	255	50	*
	MX TFP 250 255 60	250	255	60	*
	MX TFP 250 255 80	250	255	80	*
	MX TFP 250 255 100	250	255	100	*
	MX TFP 250 255 120	250	255	120	*
<b>260</b>	MX TFP 260 265 50	260	265	50	*
	MX TFP 260 265 60	260	265	60	*
	MX TFP 260 265 80	260	265	80	*
	MX TFP 260 265 100	260	265	100	*
	MX TFP 260 265 120	260	265	120	*
<b>280</b>	MX TFP 280 285 50	280	285	50	*
	MX TFP 280 285 60	280	285	60	*
	MX TFP 280 285 80	280	285	80	*
	MX TFP 280 285 100	280	285	100	*
	MX TFP 280 285 120	280	285	120	*
<b>300</b>	MX TFP 300 305 50	300	305	50	*
	MX TFP 300 305 60	300	305	60	*
	MX TFP 300 305 80	300	305	80	*
	MX TFP 300 305 100	300	305	100	*
	MX TFP 300 305 120	300	305	120	*

## Gleitlager-Anlaufscheiben wartungsarm

Palier lisse axial à entretien réduit, avec alvéoles de graissage

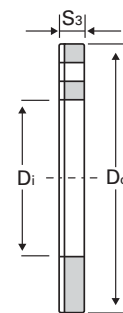

Reihen | **PAW . . P20**  
Séries

Welle Arbre Ø mm	Typ Type		Masse in mm Dimensions en mm			Preis Prix CHF
			Di	Do	S <sub>3</sub>	
<b>PAW 12 P20</b>		MX TFW 12/15	12	24	1,5	3.17
<b>PAW 14 P20</b>		MX TFW 14/15	14	26	1,5	3.42
		MX TFW 16/15	16	30	1,5	*
<b>PAW 18 P20</b>		MX TFW 18/15	18	32	1,5	4.13
<b>PAW 20 P20</b>		MX TFW 20/15	20	36	1,5	4.94
<b>PAW 22 P20</b>		MX TFW 22/15	22	38	1,5	5.17
<b>PAW 26 P20</b>		MX TFW 26/15	26	44	1,5	7.04
<b>PAW 28 P20</b>		MX TFW 28/15	28	48	1,5	7.61
<b>PAW 32 P20</b>		MX TFW 32/15	32	54	1,5	9.19
<b>PAW 38 P20</b>		MX TFW 38/15	38	62	1,5	11.60
<b>PAW 42 P20</b>		MX TFW 42/15	42	66	1,5	12.20
<b>PAW 48 P20</b>		MX TFW 48/15	48	74	2	17.10
<b>PAW 52 P20</b>		MX TFW 52/15	52	78	2	18.80

Gleitlager-Streifen  
wartungsarm, mit Stahlrücken

Palier lisse en bande  
à entretien réduit, avec alvéoles de graissage,  
avec support en acier

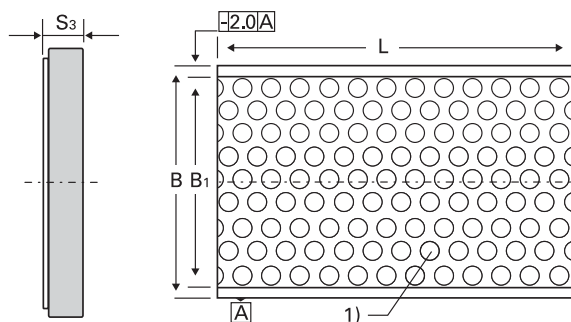

Reihen | **PAS .. P20 mit Schmiertaschen**  
Séries | **PAS .. P20 avec alvéoles de graissage**

Typ Type		Masse in mm Dimensions en mm				Preis Prix CHF
		S <sub>3</sub>	B	B <sub>1</sub>	L	
<b>PAS 10180 P20</b>		0,99	180	168	500	230.00
	MX TFS 10070	1,5	70		460	*
<b>PAS 15180 P20</b>		1,48	180	168	500	253.00
	MX TFS 15100	1,54	100		460	*
<b>PAS 20180 P20</b>		1,97	180	168	500	272.00
	MX TFS 20100	2,3	100		460	*
<b>PAS 25180 P20</b>		2,55	100		460	*
	MX TFS 25100	2,46	180	168	500	293.00

Reihen | **PAS .. P21 mit Bearbeitungszugabe und Schmiertaschen**  
Séries | **PAS .. P21 avec surépaisseur d'usinage et alvéoles de graissage**

Typ Type		Masse in mm Dimensions en mm				Preis Prix CHF
		S <sub>3</sub>	B	B <sub>1</sub>	L	
<b>PAS 10180 P21</b>		1,11	180	168	500	*
<b>PAS 15180 P21</b>		1,61	180	168	500	273.00
<b>PAS 20180 P21</b>		2,11	180	168	500	290.00
<b>PAS 25180 P21</b>		2,63	180	168	500	319.00

Reihen | **PAS .. P22 mit Bearbeitungszugabe, ohne Schmiertaschen**  
Séries | **PAS .. P22 avec surépaisseur d'usinage sans alvéoles de graissage**

Typ Type		Masse in mm Dimensions en mm				Preis Prix CHF
		S <sub>3</sub>	B	B <sub>1</sub>	L	
<b>PAS 10180 P22</b>		1,11	180	168	500	*
<b>PAS 15180 P22</b>		1,61	180	168	500	284.00
<b>PAS 20180 P22</b>		2,11	180	168	500	304.00
<b>PAS 25180 P22</b>		2,63	180	168	500	328.00