

Prix courant / Preiskatalog 2010-MEY-07-01

PALIER ET ROULEMENTS
PAGES 92-132

GEHÄUSELAGER
SEITEN 92-132

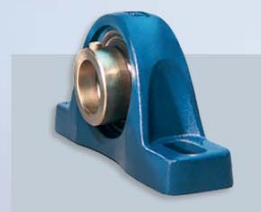

Valable dès 1.8.2008
(remplace 2006-MEY-06 du 1.3.2006)
Changement de prix réservé!

Gültig ab 1.8.2008
(ersetzt 2006-MEY-06 vom 1.3.2006)
Preisänderungen vorbehalten!

Inhalt

Sommaire

	Seiten		Pages
Inhaltsverzeichnis alphabetisch	III–XII	Répertoire alphabétique	III–XII
Wälzlager metrisch und Zubehör (07-01)	1-57	Roulements dimensions métriques et accessoires (07-01)	1-57
- Schulterkugellager	1	- Roulements à billes démontables	1
- Rillenkugellager	2-11	- Roulements rigides à billes	2-11
- Schrägkugellager	12-17	- Roulements à billes contact oblique	12-17
- Pendelkugellager	18-23	- Roulements à rotule sur billes	18-23
- Vierpunktlager	24	- Roulements à quatre points de contact	24
- Pendelrollenlager	25-30	- Roulements à rotule sur rouleaux	25-30
- Axial-Pendelrollenlager	31	- Butées à rotule sur rouleaux	31
- Zylinderrollenlager	32-37	- Roulements à rouleaux cylindriques	32-37
- Kegellager	38-41	- Roulements à rouleaux coniques	38-41
- Axial-Rillenkugellager	42-46	- Butées à billes	42-46
- Spannhülsen	47-48	- Manchons de serrage	47-48
- Abziehhülsen	49-50	- Manchons de démontage	49-50
- Wellenmuttern und Sicherungsbleche	51	- Ecrous et rondelles-frein	51
- Stehlagergehäuse geteilt	52-57	- Paliers en deux parties	52-57
Wälzlager in Zollabmessung (07-01)	58-91	Roulements dimensions pouces (07-01)	58-91
- Rillenkugellager	58-61	- Roulements rigides à billes	58-61
- Schrägkugellager	62-63	- Roulements à billes à contact oblique	62-63
- Pendelkugellager	64-65	- Roulements à rotule sur billes	64-65
- Vierpunktlager	66-67	- Roulements à quatre points de contact	66-67
- Zylinderrollenlager	68-72	- Roulements à rouleaux cylindriques	68-72
- Axial-Rillenkugellager	73-77	- Butées à billes	73-77
- Kegellager	78-91	- Roulements à rouleaux coniques	78-91
Gehäuselager (07-01)	92-132	Paliers et roulements (07-01)	92-132
- Typenübersicht Gehäuselager und Lagereinsätze mit Spannring	92-93	- Tableau des paliers et roulements à billes avec bague de blocage excentrée	92-93
- Typenübersicht Gehäuselager und Lagereinsätze mit Befestigungsschrauben oder Spannhülsen	94-101	- Tableau des paliers et roulements à billes avec fixation par vis ou manchons de serrage	94-101
- Laufrollen und Riemenspannrollen	102	- Galets d'appui et poulies de tension	102
- Kettenspannräder	103	- Pignons tendeurs de chaîne	103
- Gehäuselager	104-132	- Paliers de roulement à billes	104-132
Gelenklager und Gelenkköpfe (07-01)	133-154	Rotules et embouts à rotule (07-01)	133-154
- Gelenklager	133-139	- Rotules	133-139
- Schräg-Gelenklager	140	- Rotules à contact oblique	140
- Axial-Gelenklager	141-142	- Rotules axiales	141-142
- Gelenkköpfe	143-150	- Embouts à rotule	143-150
- Hydraulik-Gelenkköpfe	151-154	- Embouts à rotule hydrauliques et à billes à contact oblique	151-154

Inhalt











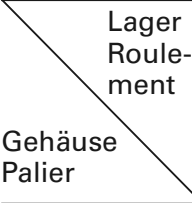









Sommaire

	Seiten		Pages
Nadellager metrisch (07-01)	155-198	Roulements à aiguilles dimensions métriques (07-01)	155-198
- Nadelkränze	155-160	- Cages à aiguilles	155-160
- Nadelhülsen und Nadelbüchsen	161-163	- Douilles à aiguilles avec et sans fond	161-163
- Nadellager ohne Innenring	164-168	- Roulements à aiguilles sans bague intérieure	164-168
- Nadellager ohne Borde, ohne Innenring	169	- Roulements à aiguilles sans épaulements sans bague intérieure	169
- Nadellager mit Innenring	170-174	- Roulements à aiguilles avec bague intérieure	170-174
- Nadellager ohne Borde, mit Innenring	175	- Roulements à aiguilles sans épaulements avec bague intérieure	175
- Stützrollen mit und ohne Axialführung, mit und ohne Innenring	176-182	- Galets d'appui avec et sans guidage axial, avec et sans bague intérieure	176-182
- Kurvenrollen	183-185	- Galets de came	183-185
- Nadel-Schräggugellager	186-187	- Roulements combinés à aiguilles et à billes à contact oblique	186-187
- Nadel-Axial-Rillenkugellager	188	- Roulements à aiguilles combinés avec butée à billes	188
- Nadel-Axial-Zylinderrollenlager	189	- Roulements à aiguilles combinés avec butée à rouleaux cylindriques	189
- Axial-Nadelkränze, Lagerscheiben und Laufscheiben	190-191	- Cages de butée à aiguilles, rondelles minces et rondelles de butée	190-191
- Axial-Zylinderrollenlager	192-193	- Butées à rouleaux cylindriques	192-193
- Innenringe	194-197	- Bagues intérieures	194-197
- Dichtringe	198	- Joints d'étanchéité	198
Miniaturkugellager (07-01)	199-209	Roulements miniatures à billes (07-01)	199-209
- Miniaturrillenkugellager	199-208	- Roulements miniatures à billes	199-208
- Miniatur Axialkugellager	209	- Butées miniatures à billes	209
Linearlager (07-01)	210-218	Guidage linéaire (07-01)	210-218
- Kugelbüchsen	210-218	- Douilles à billes	210-218
Gleitlager (07-01)	219-247	Paliers lisses (07-01)	219-247
- Gleitlager	219-247	- Paliers lisses	219-247
Zubehör (07-01)	248-278	Accessoires (07-01)	248-278
- Kugeln	248-249	- Billes	248-249
- Zylinderrollen	250	- Rouleaux cylindriques	250
- Nadelrollen	251	- Aiguilles	251
- Typenübersicht Wellendichtungen	252	- Tableau des types de joints d'étanchéité	252
- Wellendichtungen metrisch	253-255	- Joints d'étanchéité métriques	253-255
- Wellenschutzhülsen	256-266	- Douilles de protection d'arbre	256-266
- Produkte für Montage, Unterhalt und Reparatur	267-277	- Produits pour assemblage, entretien et réparation	267-277
- Wälzlagerfette	278	- Graisses pour roulements	278
Geschäftsbedingungen (07-01)	279-282	Conditions générales (07-01)	279-282
- Allgemeine Geschäftsbedingungen	279-282	- Conditions générales de vente	279-282

Gehäuselager und Lagereinsätze mit Spannring (Exzenterring)

Paliers et roulements à billes avec bague de blocage excentrée















Typenübersicht Tableau des paliers

 Lager Roulement Gehäuse Palier							
	(G)RAE-NPPB 12...-...EC(G) Seite/page 96	RALE-NPPB 24...-...EC 96	GE-KRRB 10...-...DECG 97	GE-KPPB-3 T10...-...DECG 97	RAE-NPP 13...-...EC 101	RALE-NPP 23...-...EC 101	E-KRR 11...-...DEC 101
 PASE NP-EC Seite/page 104		RASE NP-DEC Seite/page 104	TASE TNP-DEC Seite/page 104				
 PSHE SNP-EC 105		RSHE SNP-DEC 105	TSHE TSNP-DEC 105				
 FLCTE, GLCTE LFTC-EC 105							
 PCFT 106		RCJT SFT-DEC 106	TCJT TSFT-DEC 106				
		RCJTZ 107					
 PCFTR 107							
 PCF 108		RCJ SF-DEC 108	TCJ TSF-DEC 108				
 PME FC-EC 109		RME FC-DEC 109	TME TFC-DEC 109				
		RFE 110	TFE 110				
 PHE 110		RHE 110	THE 110				
 PTUE ST-EC 111		RTUE ST-DEC 111	TTUE TST-DEC 111				
 PSFT 112							
 BT-EC 112							

Gehäuselager und Lagereinsätze mit Spannring (Exzenterring)

Paliers et roulements à billes avec bague de blocage excentrée

Typenübersicht Tableau des paliers















 Lager Roulement Gehäuse Palier							
	(G)RAE-NPPB 12... EC(G)	RALE-NPPB 24... EC	GE-KRRB 10... DECG	GE-KPPB-3 T10... DECG	RAE-NPP 13... EC	RALE-NPP 23... EC	E-KRR 11... DEC
	Seite/page 96	Seite/page 96	Seite/page 97	Seite/page 97	Seite/page 101	Seite/page 101	Seite/page 101
	SLC-EC 112		SLC-DEC 112				
	PB LPB-EC 113						
	PBS 113						
	RAT SLFL-EC 113		RRT SLFL-DEC 113				
	RATR SLFT-EC 114		RRTR SLFT-DEC 114		RALTR 114		
	RA SLFE-EC GRA 114		RR SLFE-DEC GRR 114				
	MSTU 115						
					CR-B 116		
					RCSM 116	RCSM 116	
					RCR SRC-EC 116	RCR SRC-EC 116	
		RPB LPBR-EC 115					
					RCSMF 115	RCSMF 115	

* auf Anfrage
sur demande

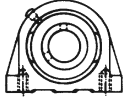
Gehäuselager und Lagereinsätze mit Befestigungsschrauben oder Spannhülsen

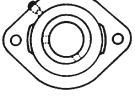
Paliers et roulements à billes avec fixation par vis ou manchons de serrage













Typenübersicht Tableau des paliers

Lager Roule- ment						
	UC 10 G	T10 G	AS/SB/UB 12 G	RB/ER/UR 11	13	UK+H 10 KG
Gehäuse Palier	Seite/page 99		Seite/page 98			Seite/page 100
	UCP NP MP 117	TNP TMP	NP-A			UKP+H NP-K MP-K 118
	UCPH 119					
	UCPA SNP 119	TSNP	SNP-A			
	UCF SF MSF 120	TSF TMSF	SF-A			UKF+H MSF-K 121
	UCFL SFT MSFT 122	TSFT TMSFT	SFT-A			UKFL+H MSFT-K 123
	LFTC 124	TLFTC	LFTC-A 124			
	FC 124	TFC	FC-A 124			
	UCFC MFC 125	TMFC				UKFC+H 125
	UCFA 126					

Gehäuselager und Lagereinsätze mit Befestigungsschrauben oder Spannhülsen

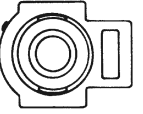
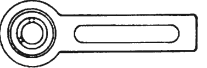
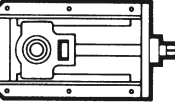
Paliers et roulements à billes avec fixation par vis ou manchons de serrage

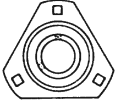
Typenübersicht Tableau des paliers

Lager Roule- ment						
	UC 10 G	T10 G	AS/SB/UB 12	RB/ER/UR 11	13	UK+H 10 KG
Gehäuse Palier	Seite/page 99		Seite/page 98			100
	UCEH SCHB SCH 127	TSCHB TSCH				
	UCC SLC 128	TLSC	SLC-A			UKC+H
	UCT ST 129	TST	ST-A			UKT+H
	BT 130	TBT	BT-A			
	UCT					
	LPB LPBR 130		SBPP LPB-A LPBR-A 130			
	SLFL 131	TSLFL	SBPFL SLFL-A 131			
	SLFT 131	TSLFT	SLFT-A 131			
	SLFE 132	TSLFE	SBPF SLFE-A 132			

* auf Anfrage
sur demande

Lagereinsätze mit Spannring (Exzenterring)

Roulements à billes avec bague de blocage excentrée

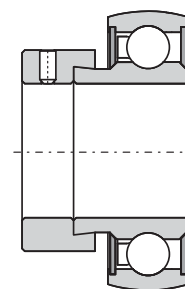

Reihen | **(G)RAE . . NPPB (RRB), RALE . . NPPB (RRB)**
Séries | **12 EC(G)**

Bohrung Alésage mm	Typ Type		Preis Prix CHF	Typ Type RALE-NPPB	Preis Prix CHF
12	(G)RAE 12 NPPB	1217-12 EC(G)	46.40		
15	(G)RAE 15 NPPB	1217-15 EC(G)	46.40		
17	(G)RAE 17 NPPB	1217-17 EC(G)	46.40		
20	(G)RAE 20 NPPB	1220-20 EC(G)	50.90	RALE 20 NPPB	49.10
25	(G)RAE 25 NPPB	1225-25 EC(G)	55.00	RALE 25 NPPB	52.70
30	(G)RAE 30 NPPB	1230-30 EC(G)	65.70	RALE 30 NPPB	63.30
35	(G)RAE 35 NPPB	1235-35 EC(G)	80.20		
40	(G)RAE 40 NPPB	1240-40 EC(G)	96.80		
45	(G)RAE 45 NPPB	1245-45 EC(G)	117.00		
50	(G)RAE 50 NPPB	1250-50 EC(G)	126.00		
55	(G)RAE 55 NPPB	1255-55 EC(G)	156.00		
60	(G)RAE 60 NPPB	1260-60 EC(G)	204.00		

Lagereinsätze mit Bohrung in Zollabmessung auf Anfrage.
Roulements avec diamètre de l'alésage en pouces sur demande.

Lagereinsätze mit Spannring (Exzenterring)

Roulements à billes avec bague de blocage excentrée

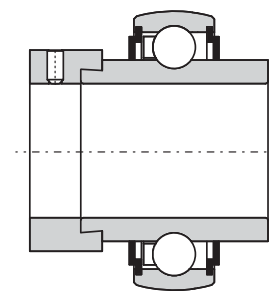

Reihen | **GE . . KRRB, GE . . KPPB3**
Séries | **10 DECG, T10 DECG**

Bohrung Alésage mm	Typ Type		Preis Prix CHF	Typ Type		Preis Prix CHF
12						
15						
17	GE 17 KRRB		59.70			
20	GE 20 KRRB	1020-20 DECG	61.30	GE 20 KPPB3	T1020-20 DECG	76.60
25	GE 25 KRRB	1025-25 DECG	65.70	GE 25 KPPB3	T1025-25 DECG	82.20
30	GE 30 KRRB	1030-30 DECG	80.40	GE 30 KPPB3	T1030-30 DECG	101.00
35	GE 35 KRRB	1035-35 DECG	96.30	GE 35 KPPB3	T1035-35 DECG	121.00
40	GE 40 KRRB	1040-40 DECG	114.00	GE 40 KPPB3	T1040-40 DECG	142.00
45	GE 45 KRRB	1045-45 DECG	135.00	GE 45 KPPB3	T1045-45 DECG	169.00
50	GE 50 KRRB	1050-50 DECG	146.00	GE 50 KPPB3	T1050-50 DECG	188.00
55	GE 55 KRRB	1055-55 DECG	189.00	GE 55 KPPB3	T1055-55 DECG	242.00
60	GE 60 KRRB	1060-60 DECG	254.00	GE 60 KPPB3	T1060-60 DECG	332.00
65	GE 65 KRRB	1065-65 DECG	377.00	GE 65 KPPB3	T1065-65 DECG	441.00
70	GE 70 KRRB	1070-70 DECG	377.00	GE 70 KPPB3	T1070-70 DECG	441.00
75	GE 75 KRRB	1075-75 DECG	488.00	GE 75 KPPB3	T1075-75 DECG	576.00
80	GE 80 KRRB		550.00	GE 80 KPPB3	T1080-80 DECG	649.00
85	GE 85 KRRB		*			
90	GE 90 KRRB		852.00			
100	GE 100 KRRB		1226.00			
120	GE 120 KRRB		1716.00			

Lagereinsätze mit Bohrung in Zollabmessung auf Anfrage.
Roulements avec diamètre de l'alésage en pouces sur demande.

Lagereinsätze mit Befestigungsschraube

Roulements à billes avec fixation par vis

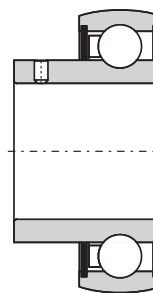

Reihen
Séries | **AS/SB/UB 2 . . , 12 . . - . . G**

Bohrung Alésage mm	Typ Type	Preis Prix CHF	Typ Type	Preis Prix CHF
12	AS/SB/UB 201	39.90		
15	AS/SB/UB 202	39.90		
17	AS/SB/UB 203	39.90		
20	AS/SB/UB 204	39.90	1220 - 20 G	39.90
25	AS/SB/UB 205	46.40	1225 - 25 G	46.40
30	AS/SB/UB 206	56.20	1230 - 30 G	56.20
35	AS/SB/UB 207	68.30	1235 - 35 G	68.30
40	AS/SB/UB 208	81.50	1240 - 40 G	81.50
45			1245 - 45 G	90.90
50			1250 - 50 G	105.00

Lagereinsätze mit Bohrung in Zollabmessung auf Anfrage.
Roulements avec diamètre de l'alésage en pouces sur demande.

Lagereinsätze mit Befestigungsschraube

Roulements à billes avec fixation par vis

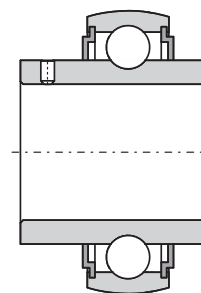

Reihen | **UC 2 . . , UC 3 . . , 10 . . - . . G**
Séries

Bohrung Alésage mm	Typ ¹⁾ Type	Preis Prix CHF	Typ Type	Preis Prix CHF	Typ Type	Preis Prix CHF
12	UC 201	43.50			1017 - 12 G	43.50
15	UC 202	43.50			1017 - 15 G	43.50
17	UC 203	43.50			1017 - 17 G	43.50
20	UC 204	43.50			1020 - 20 G	43.50
25	UC 205	50.30	UC 305	123.00	1025 - 25 G	50.30
30	UC 206	61.30	UC 306	146.00	1030 - 30 G	61.30
35	UC 207	74.20	UC 307	170.00	1035 - 35 G	74.20
40	UC 208	88.70	UC 308	204.00	1040 - 40 G	88.70
45	UC 209	98.90	UC 309	234.00	1045 - 45 G	98.90
50	UC 210	113.00	UC 310	282.00	1050 - 50 G	113.00
55	UC 211	146.00	UC 311	353.00	1055 - 55 G	146.00
60	UC 212	191.00	UC 312	406.00	1060 - 60 G	191.00
65	UC 213	250.00	UC 313	512.00	1065 - 65 G	250.00
70	UC 214	334.00	UC 314	601.00	1070 - 70 G	334.00
75	UC 215	375.00	UC 315	711.00	1075 - 75 G	375.00
80	UC 216	458.00	UC 316	864.00	1080 - 80 G	458.00
85	UC 217	535.00	UC 317	958.00	1085 - 85 G	535.00
90	UC 218	735.00	UC 318	1129.00	1090 - 90 G	735.00
95			UC 319	1286.00		
100			UC 320	1724.00		
105			UC 321	*		
110			UC 322	2150.00		
120			UC 324	2906.00		
130			UC 326	3911.00		
140			UC 328	4638.00		

1) Diese Lagereinsätze sind teilweise auch in rostbeständigem Stahl erhältlich (SS).
Ces roulements sont partiellement livrables en acier «inox» (SS).

Lagereinsätze mit Spannhülse

Roulements à billes avec manchon de serrage

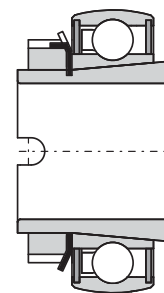

Reihen | **UK 2 .. + H 23 ..**,
Séries | **UK 3 .. + H 23 ..**

Bohrung Alésage mm	Typ Type	Preis Prix CHF	Spannhülse ¹⁾ Manchons de serrage	Typ Type	Preis Prix CHF	Spannhülse ¹⁾ Manchons de serrage
20	UK 205	60.60	H 2305	UK 305	146.00	H 2305
25	UK 206	73.00	H 2306	UK 306	146.00	H 2306
30	UK 207	90.60	H 2307	UK 307	170.00	H 2307
35	UK 208	110.00	H 2308	UK 308	204.00	H 2308
40	UK 209	126.00	H 2309	UK 309	234.00	H 2309
45	UK 210	140.00	H 2310	UK 310	294.00	H 2310
50	UK 211	179.00	H 2311	UK 311	353.00	H 2311
55	UK 212	229.00	H 2312	UK 312	406.00	H 2312
60	UK 213	271.00	H 2313	UK 313	512.00	H 2313
65	UK 215	405.00	H 2315	UK 315	711.00	H 2315
70	UK 216	502.00	H 2316	UK 316	864.00	H 2316
75	UK 217	592.00	H 2317	UK 317	958.00	H 2317
80	UK 218	748.00	H 2318	UK 318	1129.00	H 2318
85				UK 319	1286.00	H 2305
90				UK 320	1724.00	H 2320
100				UK 322	*	H 2322
110				UK 324	*	H 2324
115				UK 326	*	H 2326
125				UK 328	*	H 2328

¹⁾ Preise für Spannhülse H 23 .. siehe Seite 47

Prix pour manchon de serrage H 23 .. voir page 47

Lagereinsätze mit Spannring (Exzenterring)

Roulements à billes avec bague de blocage excentrée

Reihen | **E . . KRR, RAE . . NPP (RR),**
Séries | **RALE . . NPP (RR)**
11 DEC, 13 EC



Bohrung Alésage mm	Typ Type	Preis Prix CHF	Typ Type	Preis Prix CHF	Typ Type	Preis Prix CHF		
12			RAE 12 NPP	1317 - 12 EC		46.40		
15			RAE 15 NPP	1317 - 15 EC		46.40		
17			RAE 17 NPP	1317 - 17 EC		46.40		
20	E 20 KRR	1120 - 20 DEC	61.30	RAE 20 NPP	1320 - 20 EC	50.90	RALE 20 NPP	49.10
25	E 25 KRR	1125 - 25 DEC	65.70	RAE 25 NPP	1325 - 25 EC	55.00	RALE 25 NPP	52.70
30	E 30 KRR	1130 - 30 DEC	80.40	RAE 30 NPP	1330 - 30 EC	65.70	RALE 30 NPP	63.30
35	E 35 KRR	1135 - 35 DEC	96.30	RAE 35 NPP	1335 - 35 EC	80.20		
40	E 40 KRR	1140 - 40 DEC	114.00	RAE 40 NPP	1340 - 40 EC	96.80		
45	E 45 KRR	1145 - 45 DEC	135.00	RAE 45 NPP	1345 - 45 EC	117.00		
50	E 50 KRR	1150 - 50 DEC	146.00	RAE 50 NPP	1350 - 50 EC	126.00		
55		1155 - 55 DEC	*					
60	E 60 KRR	1160 - 60 DEC	243.00					
65		1165 - 65 DEC	*					
70	E 70 KRR	1170 - 70 DEC	377.00					
75		1175 - 75 DEC	*					

Rillenkugellager Roulements à billes

Reihen | **2 . . NPPB, CB/CS/SC 2 . . ,**
Séries | **17262 . . 2RS**



2 . . KRR



Bohrung Alésage mm	Typ Type	Preis Prix CHF	Typ Type	Preis Prix CHF		
12	201 NPPB	CB/CS/SC 201	1726201 2RS	30.00		
15		CB/CS/SC 202	1726202 2RS	30.00	202 KRR	37.60
17	203 NPPB	CB/CS/SC 203	1726203 2RS	30.00	203 KRR	41.20
20	204 NPPB	CB/CS/SC 204	1726204 2RS	32.80	204 KRR	45.60
25	205 NPPB	CB/CS/SC 205	1726205 2RS	37.30	205 KRR	51.80
30	206 NPPB	CB/CS/SC 206	1726206 2RS	46.70	206 KRR	63.10
35	207 NPPB	CB/CS/SC 207	1726207 2RS	57.50	207 KRR	*
40	208 NPPB	CB/CS/SC 208	1726208 2RS	72.20	208 KRR	*
45	209 NPPB	CB/CS/SC 209	1726209 2RS	82.20	209 KRR	*
50	210 NPPB	CB/CS/SC 210	1726210 2RS	92.20	210 KRR	115.00

* auf Anfrage
sur demande

Laufrollen

Galets d'appui

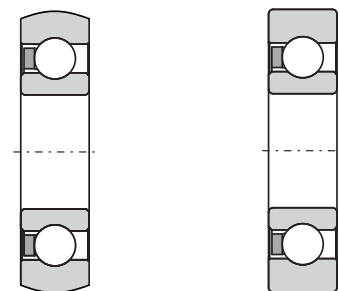

ballig

zylindrisch

Reihen | LR 2...NPP(U), LR 52...KDD(U)
Séries

Typ Type	Preis Prix CHF	Typ Type	Preis Prix CHF
LR 200 NPP(U)	40.90	LR 5200 KDD(U)	94.10
LR 201 NPP(U)	43.70	LR 5201 KDD(U)	94.10
LR 202 NPP(U)	40.10	LR 5202 KDD(U)	97.40
LR 203 NPP(U)	51.50	LR 5203 KDD(U)	107.00
LR 204 NPP(U)	52.10	LR 5204 KDD(U)	114.00
LR 205 NPP(U)	76.60	LR 5205 KDD(U)	134.00
LR 206 NPP(U)	91.90	LR 5206 KDD(U)	159.00
LR 207 NPP(U)	116.00	LR 5207 KDD(U)	180.00
LR 208 NPP(U)	140.00	LR 5208 KDD(U)	191.00
LR 209 NPP(U)	156.00		

Riemenspannrollen

Poulies de tension

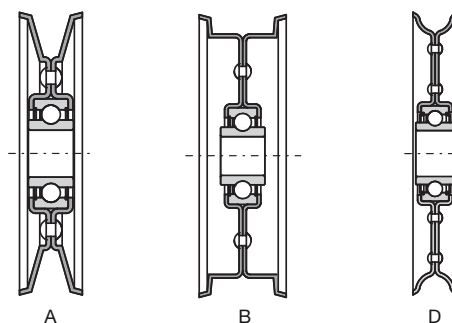

A

B

D

Typ Type	Bauart modèle	Preis Prix CHF
200 - E - 1268	A. 15. 90.LO	A 74.50
- 10 874	A. 17. 102.KO	A 112.00
008 - 10 482	A. 13. 129.LO	A 85.70
010 - 10 482	A. 16. 129.LO	A 79.60
008 - 10 853	A. 13. 186.LO	A 119.00
010 - 10 853	A. 16. 186.LO	A 119.00
200 - E - 1290	B. 15. 92.LO	B 79.20
008 - 10 601	B. 13. 117.LO	B 79.80
010 - 10 601	B. 16. 117.LO	B 79.80
008 - 10 483	B. 13. 159.LO	B 98.60
010 - 10 483	B. 16. 159.LO	B 89.40
008 - 10 731	B. 13. 222.LO	B *
010 - 10 731	B. 16. 222.LO	B 116.00
205 - E - 1313	D. 25. 150.LO	D 108.00
V - 811-2	D. 20. 160.LO	D 91.30

Kettenspannräder

Pignons tendeurs de chaîne

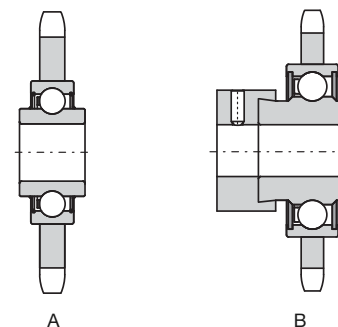

Ausführung für Ketten nach DIN 8187
Exécutions pour chaînes selon DIN 8187

Typ Type			Ausführung modèle	Preis Prix CHF
3/2 - 06 B 20 S	16.L0.06.10.20.08	KS.2038.B	A	66.70
3/2 - 08 B 16 S	16.L0.08.10.16.08	KS.1612.B	A	69.80
3/2 - 08 B 18 S	16.L0.08.10.18.08	KS.1812.B	A	73.00
3/2 - 08 B 18 SH	16.L0.08.10.18.09		A	85.50
3/2 - 10 B 14 S	16.L0.10.10.14.08	KS.1458.B	A	72.90
3/2 - 10 B 17 S	16.L0.10.10.17.08	KS.1758.B	A	84.90
3/2 - 10 B 17 SH	16.L0.10.10.17.09		A	99.80
3/2 - 12 B 13 S	16.L0.12.10.13.08	KS.1334.B	A	86.20
3/2 - 12 B 15 S	16.L0.12.10.15.08		A	99.80
3/2 - 12 B 15 SH	16.L0.12.10.15.09			120.00
3/2 - 12 B 17 S	16.L0.12.10.17.15	KS.1734.B	A	121.00
4 - 16 B 12	20.L0.16.10.12.15	KS.1210.B	A	120.00
4 - 16 B 12 H	20.L0.16.10.12.16		A	149.00
4 - 20 B 13	25.L0.20.10.13.15		A	261.00
15 - 06 B 20 S	15.B0.06.10.20.08		B	80.50
15 - 08 B 16 S	15.B0.08.10.16.08	KS.1612.EB	B	79.40
15 - 10 B 14 S	15.B0.10.10.14.08		B	86.20
15 - 12 B 13 S	15.B0.12.10.13.08		B	101.00
20 - 10 B 17	20.B0.10.10.17.15	KS.1758.EB	B	104.00
20 - 16 B 10	20.B0.16.10.10.15	KS.1010.EB	B	130.00
25 - 08 B 19 S	25.B0.08.10.19.08		B	94.30
30 - 24 B 15	30.B0.24.10.15.15	KS.1515.EB	B	*

* auf Anfrage
sur demande

Stehlager mit Gussgehäuse

Paliers à semelle en fonte avec roulement

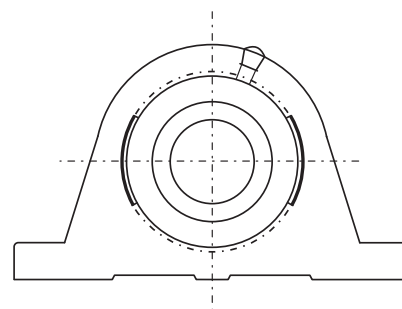

Reihen | **PASE . . . , RASE . . . , TASE . . .**
Séries | **NP . . EC, NP . . DEC, TNP . . DEC**

Bohrung Alésage mm	Typ Type		Preis Prix CHF	Typ Type		Preis Prix CHF	Typ Type		Preis Prix CHF
12	PASE 12	NP12 EC	73.30						
15	PASE 15	NP15 EC	73.30						
17	PASE 17	NP17 EC	73.30	RASE 17	NP17 DEC	86.60			
20	PASE 20	NP20 EC	77.90	RASE 20	NP20 DEC	88.20	TASE 20	TNP 20 DEC	105.00
25	PASE 25	NP25 EC	87.90	RASE 25	NP25 DEC	98.60	TASE 25	TNP 25 DEC	116.00
30	PASE 30	NP30 EC	106.00	RASE 30	NP30 DEC	121.00	TASE 30	TNP 30 DEC	140.00
35	PASE 35	NP35 EC	124.00	RASE 35	NP35 DEC	140.00	TASE 35	TNP 35 DEC	164.00
40	PASE 40	NP40 EC	144.00	RASE 40	NP40 DEC	161.00	TASE 40	TNP 40 DEC	188.00
45	PASE 45	NP45 EC	172.00	RASE 45	NP45 DEC	190.00	TASE 45	TNP 45 DEC	224.00
50	PASE 50	NP50 EC	193.00	RASE 50	NP50 DEC	214.00	TASE 50	TNP 50 DEC	255.00
55	PASE 55	NP55 EC	245.00	RASE 55	NP55 DEC	271.00	TASE 55	TNP 55 DEC	321.00
60	PASE 60	NP60 EC	310.00	RASE 60	NP60 DEC	348.00	TASE 60	TNP 60 DEC	423.00
65				RASE 65	NP65 DEC	587.00	TASE 65	TNP 65 DEC	653.00
70				RASE 70	NP70 DEC	587.00	TASE 70	TNP 70 DEC	653.00
75				RASE 75	NP75 DEC	719.00	TASE 75	TNP 75 DEC	806.00
80				RASE 80	NP80 DEC	805.00	TASE 80	TNP 80 DEC	904.00
85									
90				RASE 90	NP90 DEC	1283.00			
100				RASE 100		1791.00			
120				RASE 120		2769.00			

Gehäuselager mit Lagereinsatz, Bohrung in Zollabmessung auf Anfrage.
Paliers avec roulement, diamètre de l'alésage en pouces sur demande.

Stehlager mit Gussgehäuse

Paliers à semelle en fonte avec roulement

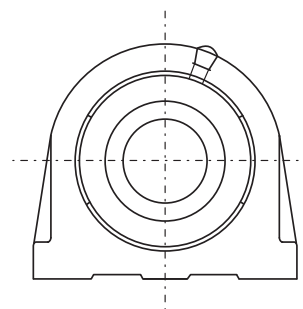

Reihen | **PSHE . . , RSHE . . , TSHE . .**
Séries | **SNP . . EC, SNP . . DEC, TSNP . . DEC**

Bohrung Alésage mm	Typ Type	Preis Prix CHF	Typ Type	Preis Prix CHF	Typ Type	Preis Prix CHF
12	PSHE 12	SNP 12 EC		83.50		
15	PSHE 15	SNP 15 EC		83.50		
17	PSHE 17	SNP 17 EC	RSHE 17	SNP 17 DEC	96.80	
20	PSHE 20	SNP 20 EC	RSHE 20	SNP 20 DEC	98.40	TSHE 20 TSNP 20 DEC 115.00
25	PSHE 25	SNP 25 EC	RSHE 25	SNP 25 DEC	113.00	TSHE 25 TSNP 25 DEC 129.00
30	PSHE 30	SNP 30 EC	RSHE 30	SNP 30 DEC	138.00	TSHE 30 TSNP 30 DEC 159.00
35	PSHE 35	SNP 35 EC	RSHE 35	SNP 35 DEC	162.00	TSHE 35 TSNP 35 DEC 186.00
40	PSHE 40	SNP 40 EC	RSHE 40	SNP 40 DEC	188.00	TSHE 40 TSNP 40 DEC 217.00
45	PSHE 45	SNP 45 EC	RSHE 45	SNP 45 DEC	220.00	TSHE 45 TSNP 45 DEC 252.00
50	PSHE 50	SNP 50 EC	RSHE 50	SNP 50 DEC	238.00	TSHE 50 TSNP 50 DEC 280.00
55	PSHE 55		RSHE 55	SNP 55 DEC	291.00	TSHE 55 TSNP 55 DEC 341.00
60	PSHE 60		RSHE 60	SNP 60 DEC	380.00	TSHE 60 TSNP 60 DEC 453.00

Flanschlager mit Gussgehäuse

Paliers-appiques en fonte avec roulement

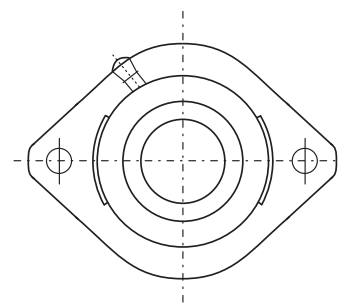

Reihen | **FLCTE . . , GLCTE . .**
Séries | **LFTC . . EC**

Bohrung Alésage mm	Typ Type	Preis Prix CHF	Typ Type	Preis Prix CHF
12	FLCTE 12	71.80	GLCTE 12 LFTC 12 EC	73.30
15	FLCTE 15	71.80	GLCTE 15 LFTC 15 EC	73.30
17	FLCTE 17	71.80	GLCTE 17 LFTC 17 EC	73.30
20	FLCTE 20	76.30	GLCTE 20 LFTC 20 EC	77.90
25	FLCTE 25	83.30	GLCTE 25 LFTC 25 EC	87.90
30	FLCTE 30	101.00	GLCTE 30 LFTC 30 EC	106.00
35	FLCTE 35	120.00	GLCTE 35 LFTC 35 EC	124.00
40	FLCTE 40	139.00	GLCTE 40 LFTC 40 EC	144.00

Flanschlager mit Gussgehäuse

Paliers-appliques en fonte avec roulement

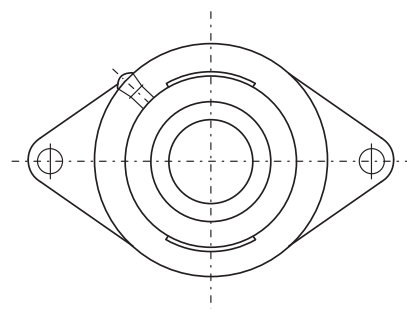

Reihen | **PCFT . . . , RCJT . . . , TCJT . . .**
Séries | **SFT . . . DEC, TSFT . . . DEC**

Bohrung Alésage mm	Typ Type	Preis Prix CHF	Typ Type	Preis Prix CHF	Typ Type	Preis Prix CHF	
12	PCFT 12	73.30					
15	PCFT 15	73.30					
17	PCFT 17	73.30	RCJT 17	86.60			
20	PCFT 20	77.90	RCJT 20	SFT 20 DEC	88.20	TCJT 20 TSFT 20 DEC	105.00
25	PCFT 25	87.90	RCJT 25	SFT 25 DEC	98.60	TCJT 25 TSFT 25 DEC	116.00
30	PCFT 30	106.00	RCJT 30	SFT 30 DEC	121.00	TCJT 30 TSFT 30 DEC	140.00
35	PCFT 35	124.00	RCJT 35	SFT 35 DEC	140.00	TCJT 35 TSFT 35 DEC	164.00
40	PCFT 40	144.00	RCJT 40	SFT 40 DEC	161.00	TCJT 40 TSFT 40 DEC	188.00
45	PCFT 45	172.00	RCJT 45	SFT 45 DEC	190.00	TCJT 45 TSFT 45 DEC	224.00
50	PCFT 50	193.00	RCJT 50	SFT 50 DEC	214.00	TCJT 50 TSFT 50 DEC	255.00
55			RCJT 55	SFT 55 DEC	271.00	TCJT 55 TSFT 55 DEC	321.00
60			RCJT 60	SFT 60 DEC	348.00	TCJT 60 TSFT 60 DEC	*
65			RCJT 65		587.00	TCJT 65	653.00
70			RCJT 70		587.00	TCJT 70	*
75			RCJT 75		719.00	TCJT 75	*

Gehäuselager mit Lagereinsatz, Bohrung in Zollabmessung auf Anfrage.
Paliers avec roulement, diamètre de l'alésage en pouces sur demande.

Flanschlager mit Gussgehäuse (mit Zentrieransatz)

Paliers-appliques en fonte avec roulement
(et épaulement de centrage)

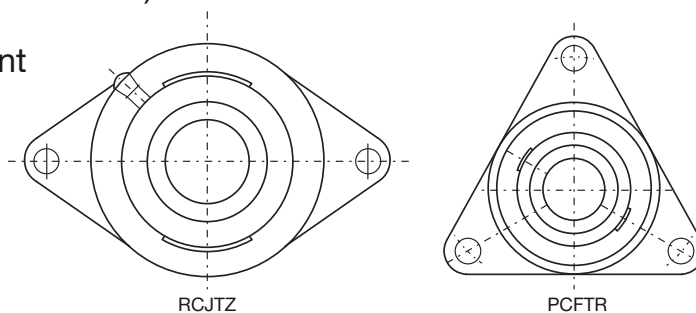

Reihen
Séries | **RCJ TZ . . , PCF TR . .**

Bohrung Alésage mm	Typ Type	Preis Prix CHF	Typ Type	Preis Prix CHF
12			PCFTR 12	96.60
15			PCFTR 15	96.60
17			PCFTR 17	96.60
20	RCJ TZ 20	113.00	PCFTR 20	102.00
25	RCJ TZ 25	127.00	PCFTR 25	116.00
30	RCJ TZ 30	152.00	PCFTR 30	137.00
35	RCJ TZ 35	177.00	PCFTR 35	161.00
40	RCJ TZ 40	199.00	PCFTR 40	183.00
45	RCJ TZ 45	230.00	PCFTR 45	212.00
50	RCJ TZ 50	250.00	PCFTR 50	231.00
55				
60	RCJ TZ 60	378.00		

Gehäuselager mit Lagereinsatz, Bohrung in Zollabmessung auf Anfrage.
Paliers avec roulement, diamètre de l'alésage en pouces sur demande.

Flanschlager mit Gussgehäuse

Paliers-appliques en fonte avec roulement

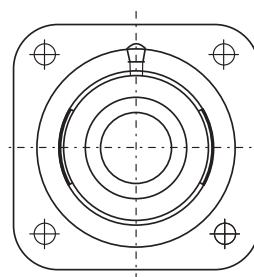

Reihen | **PCF . . . , RCJ . . . , TCJ . . .**
Séries | **SF . . DEC, TSF . . DEC**

Bohrung Alésage mm	Typ Type	Preis Prix CHF	Typ Type		Preis Prix CHF	Typ Type		Preis Prix CHF
12	PCF 12	*						
15	PCF 15	*						
17	PCF 17	*	RCJ 17		86.60			
20	PCF 20	77.90	RCJ 20	SF 20 DEC	88.20	TCJ 25	TSF 25 DEC	116.00
25	PCF 25	87.90	RCJ 25	SF 25 DEC	98.60	TCJ 30	TSF 30 DEC	140.00
30	PCF 30	106.00	RCJ 30	SF 30 DEC	121.00			
35	PCF 35	124.00	RCJ 35	SF 35 DEC	140.00	TCJ 35	TSF 35 DEC	164.00
40	PCF 40	144.00	RCJ 40	SF 40 DEC	161.00	TCJ 40	TSF 40 DEC	188.00
45	PCF 45	172.00	RCJ 45	SF 45 DEC	190.00	TCJ 45	TSF 45 DEC	224.00
50	PCF 50	193.00	RCJ 50	SF 50 DEC	214.00	TCJ 50	TSF 50 DEC	255.00
55			RCJ 55	SF 55 DEC	271.00	TCJ 55	TSF 55 DEC	321.00
60			RCJ 60	SF 60 DEC	348.00	TCJ 60	TSF 60 DEC	423.00
65			RCJ 65	SF 65 DEC	587.00	TCJ 65	TSF 65 DEC	653.00
70			RCJ 70	SF 70 DEC	587.00	TCJ 70	TSF 70 DEC	653.00
75			RCJ 75	SF 75 DEC	719.00	TCJ 75	TSF 75 DEC	806.00
80			RCJ 80		805.00	TCJ 80		904.00
90			RCJ 90		1283.00			
100			RCJ 100		1791.00			
120			RCJ 120		2769.00			

Gehäuselager mit Lagereinsatz, Bohrung in Zollabmessung auf Anfrage.
Paliers avec roulement, diamètre de l'alésage en pouces sur demande.

Flanschlager mit Gussgehäuse mit Zentrieransatz

Paliers-appliques en fonte avec roulement
et épaulement de centrage

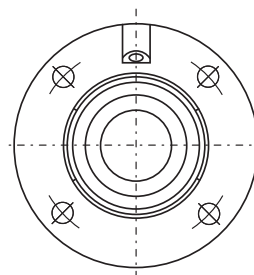

Reihen | **PME . . ., RME . . ., TME . . .**
Séries | **FC . . EC, FC . . DEC, TFC . . DEC**

Bohrung Alésage mm	Typ Type		Preis Prix CHF	Typ Type		Preis Prix CHF	Typ Type		Preis Prix CHF
20	PME 20	FC 20 EC	91.60	RME 20	FC 20 DEC	104.00	TME 20	TFC 20DEC	118.00
25	PME 25	FC 25 EC	106.00	RME 25	FC 25 DEC	116.00	TME 25	TFC 25DEC	132.00
30	PME 30	FC 30 EC	126.00	RME 30	FC 30 DEC	141.00	TME 30	TFC 30DEC	162.00
35	PME 35	FC 35 EC	145.00	RME 35	FC 35 DEC	162.00	TME 35	TFC 35 DEC	186.00
40	PME 40	FC 40 EC	173.00	RME 40	FC 40 DEC	188.00	TME 40	TFC 40 DEC	217.00
45	PME 45	FC 45 EC	203.00	RME 45	FC 45 DEC	221.00	TME 45	TFC 45 DEC	255.00
50	PME 50	FC 50 EC	220.00	RME 50	FC 50 DEC	238.00	TME 50	TFC 50 DEC	280.00
55	PME 55		267.00	RME 55	FC 55 DEC	291.00	TME 55	TFC 55 DEC	341.00
60	PME 60		341.00	RME 60	FC 60 DEC	380.00	TME 60	TFC 60 DEC	453.00
65				RME 65		625.00	TME 65		689.00
70				RME 70		625.00	TME 70		689.00
75				RME 75		780.00	TME 75		867.00
80				RME 80		879.00	TME 80		979.00
90				RME 90		1484.00			
100				RME 100		1992.00			
120				RME 120		2850.00			

Gehäuselager mit Lagereinsatz, Bohrung in Zollabmessung auf Anfrage.
Paliers avec roulement, diamètre de l'alésage en pouces sur demande.

Flanschlager mit Gussgehäuse mit Zentrieransatz

Paliers-appliques en fonte avec roulement
et épaulement de centrage

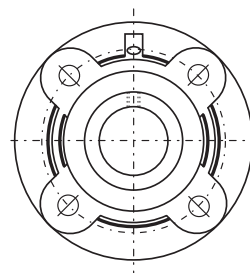

Reihen
Séries | **RFE . . , TFE . .**

Bohrung Alésage mm	Typ Type	Preis Prix CHF	Typ Type	Preis Prix CHF
20				
25	RFE 25	116.00	TFE 25	132.00
30	RFE 30	141.00	TFE 30	162.00
35	RFE 35	162.00	TFE 35	186.00
40	RFE 40	188.00	TFE 40	217.00
45	RFE 45	221.00	TFE 45	255.00
50	RFE 50	238.00	TFE 50	280.00
55				
60	RFE 60	380.00	TFE 60	453.00

Spannlager mit Gussgehäuse

Coulisseaux tendeurs en fonte avec roulement

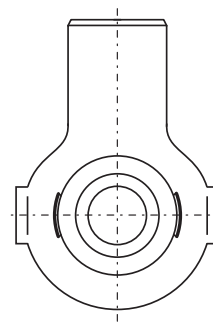

Reihen
Séries | **PHE . . , RHE . . , THE . .**

Bohrung Alésage mm	Typ Type	Preis Prix CHF	Typ Type	Preis Prix CHF	Typ Type	Preis Prix CHF
20	PHE 20	91.60	RHE 20	104.00		
25	PHE 25	106.00	RHE 25	104.00	THE 25	132.00
30	PHE 30	126.00	RHE 30	141.00	THE 30	162.00
35	PHE 35	145.00	RHE 35	162.00	THE 35	186.00
40	PHE 40	173.00	RHE 40	188.00	THE 40	217.00
45	PHE 45	203.00	RHE 45	221.00	THE 45	255.00
50	PHE 50	220.00	RHE 50	238.00	THE 50	280.00

Spannlager mit Gussgehäuse

Coulisseaux tendeurs en fonte avec roulement

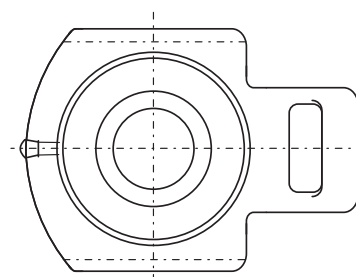

Reihen | **PTUE ... , RTUE ... , TTUE ...**
Séries | **ST ... EC, ST ... DEC, TST ... DEC**

Bohrung Alésage mm	Typ ¹⁾ Type		Preis Prix CHF	Typ ¹⁾ Type		Preis Prix CHF	Typ ¹⁾ Type		Preis Prix CHF
20	PTUE 20	ST 20 EC	91.60	RTUE 20	ST 20 DEC	104.00			
25	PTUE 25	ST 25 EC	106.00	RTUE 25	ST 25 DEC	116.00	TTUE 25	TST 25DEC	132.00
30	PTUE 30	ST 30 EC	126.00	RTUE 30	ST 30 DEC	141.00	TTUE 30	TST 30DEC	162.00
35	PTUE 35	ST 35 EC	145.00	RTUE 35	ST 35 DEC	162.00	TTUE 35	TST 35 DEC	186.00
40	PTUE 40	ST 40 EC	173.00	RTUE 40	ST 40 DEC	188.00	TTUE 40	TST 40 DEC	217.00
45	PTUE 45	ST 45 EC	203.00	RTUE 45	ST 45 DEC	221.00	TTUE 45	TST 45 DEC	255.00
50	PTUE 50	ST 50 EC	220.00	RTUE 50	ST 50 DEC	238.00	TTUE 50	TST 50 DEC	280.00
55	PTUE 55		267.00	RTUE 55	ST 55 DEC	291.00	TTUE 55	TST 55 DEC	341.00
60	PTUE 60		341.00	RTUE 60	ST 60 DEC	380.00	TTUE 60	TST 60 DEC	453.00
65				RTUE 65	ST 65 DEC	625.00			
70				RTUE 70	ST 70 DEC	625.00	TTUE 70		689.00
75				RTUE 75	ST 75 DEC	780.00	TTUE 75		*
80				RTUE 80		879.00	TTUE 80		979.00
90				RTUE 90		1484.00			
100				RTUE 100		1992.00			
120				RTUE 120		2850.00			

¹⁾ Breite der Führungsnut kann variieren
Largeur de guide de rainure peut varier

Gehäuselager mit Lagereinsatz, Bohrung in Zollabmessung auf Anfrage.
Paliers avec roulement, diamètre de l'alésage en pouces sur demande.

Spann- und Hülsenlager mit Gussgehäuse

Coulisseaux tendeurs et cartouches en fonte avec roulement

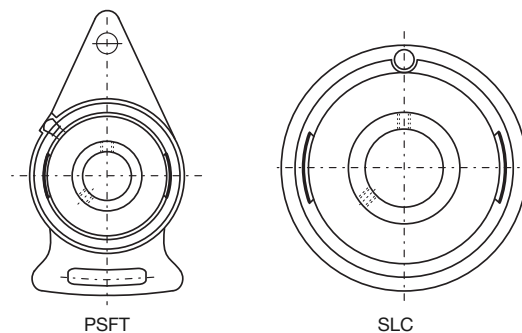

Reihen | **PSFT ..**
Séries | **SLC .. EC, SLC .. DEC**

Bohrung Alésage mm	Typ Type	Preis Prix CHF	Typ Type	Preis Prix CHF	Typ Type	Preis Prix CHF
12			SLC 12 EC	78.90		
15			SLC 15 EC	78.90		
17			SLC 17 EC	78.90		
20	PSFT 20	88.00	SLC 20 EC	78.80	SLC 20 DEC	*
25	PSFT 25	101.00	SLC 25 EC	92.00	SLC 25 DEC	*
30	PSFT 30	124.00	SLC 30 EC	117.00	SLC 30 DEC	*
35	PSFT 35	145.00	SLC 35 EC	139.00	SLC 35 DEC	*
40			SLC 40 EC	166.00	SLC 40 DEC	*
45			SLC 45 EC	184.00	SLC 45 DEC	*
50			SLC 50 EC	217.00	SLC 50 DEC	237.00
55					SLC 55 DEC	327.00
60					SLC 60 DEC	*
65					SLC 65 DEC	*

Transportbandspanner mit Gussgehäuse

Tendeurs en fonte avec roulement
(pour bandes transporteuses)

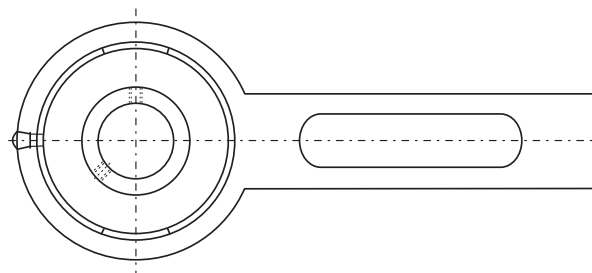

Reihe | **BT .. EC**
Série

Bohrung Alésage mm	Typ Type	Preis Prix CHF
25	BT 25 EC	206.00
30		
35	BT 35 EC	262.00

Stehlager mit Stahlblechgehäuse

Paliers à semelle en tôle d'acier avec roulement

Reihen | **PB .., PBS ..**
Séries | **LPB .. EC**

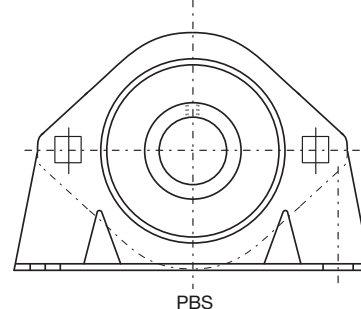
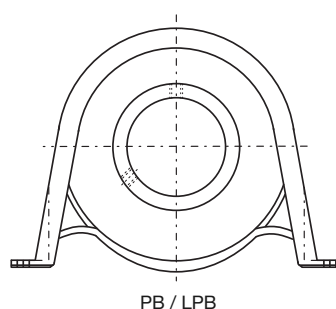

Bohrung Alésage mm	Typ Type		Preis Prix CHF	Typ Type	Preis Prix CHF
12	PB 12	LPB 12 EC	56.70	PBS 12	71.90
15	PB 15	LPB 15 EC	56.70	PBS 15	71.90
17	PB 17	LPB 17 EC	56.70	PBS 17	71.90
20	PB 20	LPB 20 EC	62.50	PBS 20	75.60
25	PB 25	LPB 25 EC	67.00	PBS 25	80.80
30	PB 30	LPB 30 EC	79.80	PBS 30	98.60
35		LPB 35 EC	102.00	PBS 35	120.00
40				PBS 40	144.00

Flanschlager mit Stahlblechgehäuse

Paliers-appiques en tôle d'acier avec roulement

Reihen | **RAT .., RRT ..**
Séries | **SLFL .. EC, SLFL .. DEC**

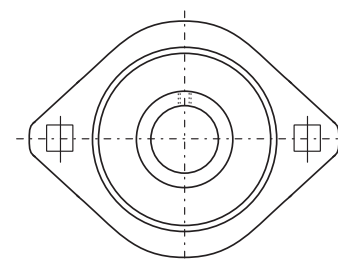

Bohrung Alésage mm	Typ Type		Preis Prix CHF	Typ Type	Preis Prix CHF
12	RAT 12	SLFL 12 EC	56.70		
15	RAT 15	SLFL 15 EC	56.70		
17	RAT 17	SLFL 17 EC	56.70		
20	RAT 20	SLFL 20 EC	62.50	RRT 20	SLFL 20 DEC *
25	RAT 25	SLFL 25 EC	67.00	RRT 25	SLFL 25 DEC *
30	RAT 30	SLFL 30 EC	79.80	RRT 30	SLFL 30 DEC *
35	RAT 35	SLFL 35 EC	98.40	RRT 35	*
40	RAT 40		120.00	RRT 40	*

* auf Anfrage
sur demande

Flanschlager mit Stahlblechgehäuse

Paliers-appliques en tôle d'acier avec roulement

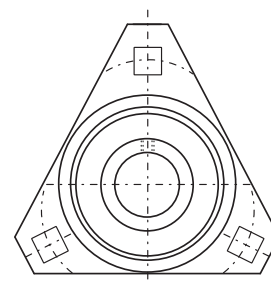

Reihen | **RALTR . . , RATR . . , RRTR . .**
Séries | **SLFT . . EC, SLFT . . DEC**

Bohrung Alésage mm	Typ Type	Preis Prix CHF	Typ Type	Preis Prix CHF	Typ Type	Preis Prix CHF
20	RALTR 20	61.40	RATR 20 SLFT 20 EC	62.50	RRTR 20 SLFT 20 DEC	*
25	RALTR 25	*	RATR 25 SLFT 25 EC	67.00	RRTR 25 SLFT 25 DEC	*
30	RALTR 30	*	RATR 30 SLFT 30 EC	79.80	RRTR 30 SLFT 30 DEC	*
35			RATR 35 SLFT 35 EC	98.40	RRTR 35 SLFT 35 DEC	*

Flanschlager mit Stahlblechgehäuse

Paliers-appliques en tôle d'acier avec roulement

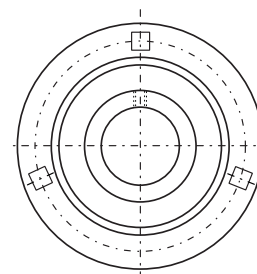

Reihen | **RA . . , RR . . , GRA . . , GRR . .**
Séries | **SLFE . . EC, SLFE . . DEC**

Bohrung Alésage mm	Typ Type	Preis Prix CHF	Typ Type	Preis Prix CHF	Typ Type	Preis Prix CHF	Typ Type	Preis Prix CHF
12	RA 12	SLFE 12 EC 56.70						
15	RA 15	SLFE 15 EC 56.70						
17	RA 17	SLFE 17 EC 56.70						
20	RA 20	SLFE 20 EC 62.50	RR 20	SLFE 20 DEC *	GRA 20	71.90	GRR 20	*
25	RA 25	SLFE 25 EC 67.00	RR 25	SLFE 25 DEC *	GRA 25	74.10	GRR 25	*
30	RA 30	SLFE 30 EC 79.80	RR 30	SLFE 30 DEC *	GRA 30	89.20	GRR 30	*
35	RA 35	SLFE 35 EC 98.40	RR 35	SLFE 35 DEC *	GRA 35	111.00	GRR 35	*
40	RA 40	SLFE 40 EC 120.00	RR 40	SLFE 40 DEC *	GRA 40	134.00	GRR 40	*
45	RA 45	SLFE 45 EC 141.00	RR 45	SLFE 45 DEC 156.00	GRA 45	168.00	GRR 45	*
50	RA 50	SLFE 50 EC 161.00	RR 50	SLFE 50 DEC *	GRA 50	181.00	GRR 50	*
55	RA 55	SLFE 55 EC 230.00	RR 55	SLFE 55 DEC *	GRA 55	*	GRR 55	*
60	RA 60	SLFE 60 EC 288.00	RR 60	SLFE 60 DEC *				

Spannlagergehäuse

Coulisseaux tendeurs

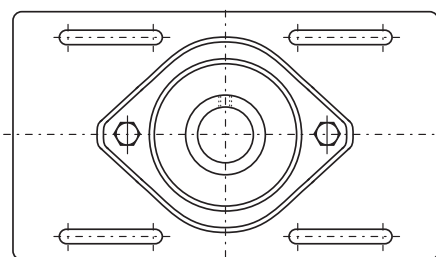

Reihe | **MSTU ..**
Série

Bohrung Alésage mm	Typ Type	Preis Prix CHF
20		
25	MSTU 25	86.70
30	MSTU 30	104.00

Steh- und Flanschlager mit Stahlblechgehäuse und Gummidämmring

Paliers à semelle et paliers-appliques en tôle d'acier avec roulement et amortisseur en caoutchouc

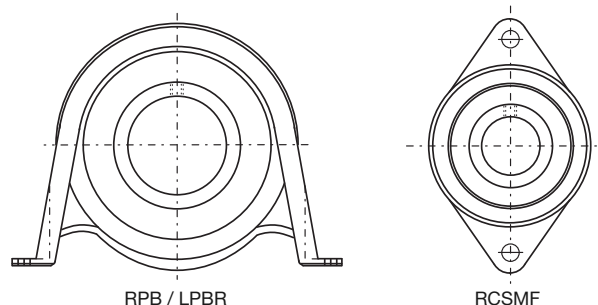

Reihen | **RPB .., RCSMF ..**
Séries | **LPBR .. EC**

Bohrung Alésage mm	Typ Type	Preis Prix CHF	Typ Type	Preis Prix CHF
12	RPB 12 LPBR 12 EC	79.40	RCSMF 12	98.60
15	RPB 15 LPBR 15 EC	79.80	RCSMF 15	98.60
17	RPB 17 LPBR 17 EC	109.00	RCSMF 17	98.60
20	RPB 20 LPBR 20 EC	87.40	RCSMF 20	105.00
25	RPB 25 LPBR 25 EC	101.00	RCSMF 25	117.00
30	RPB 30	120.00	RCSMF 30	136.00

Spannringlager mit Gummidämmring

Roulements à billes avec bague de blocage excentrée et amortisseur en caoutchouc

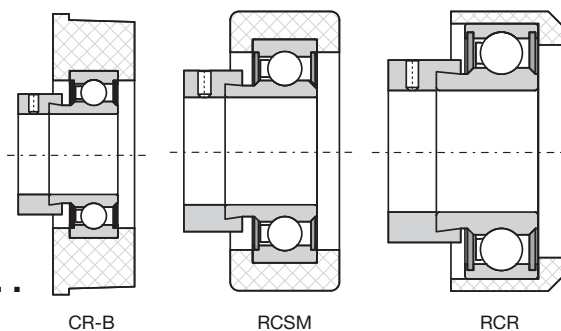

Reihen | **CR-B . . , RCSM . . , RCR-A . . , RCR-B . .**
Séries | **SRM . . EC, SRC . . EC**

Bohrung Alésage mm	Typ Type	Preis Prix CHF	Typ Type (SRM . . EC)	Preis Prix CHF	Typ Type (SRC . . EC)	Preis Prix CHF
12			RCSM-B 12/65	*		
15			RCSM-B 15/65	76.90		
17			RCSM-B 17/65	76.90		
20	CR-B 20/76	72.20	RCSM-B 20/65	81.70	RCR-A 20/46	70.50
	CR-B 20/83	72.20				
25	CR-B 25/70	73.60	RCSM-B 25/65	93.20	RCR-B 25/57	86.20
	CR-B 25/72	74.70				
	CR-B 25/83	78.10				
30	CR-B 30/83	94.80	RCSM-A 30/65	113.00		
	CR-B 30/92	101.00				
35	CR-B 35/110	136.00				

Gehäuselager mit Lagereinsatz, Bohrung in Zollabmessung auf Anfrage.
Paliers avec roulement, diamètre de l'alésage en pouces sur demande.

Stehlager mit Gussgehäuse

Paliers à semelle en fonte avec roulement

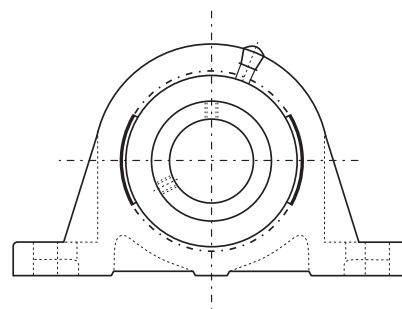

Reihen | **UCP 2 . . , UCP 3 . .**
Séries | **NP . . , MP . .**

Bohrung Alésage mm	Typ ¹⁾ Type		Preis Prix CHF	Typ Type	Preis Prix CHF	Typ Type	Preis Prix CHF
12	UCP 201	NP 12	70.40				
15	UCP 202	NP 15	70.40				
17	UCP 203	NP 17	70.40				
20	UCP 204	NP 20	70.40				
25	UCP 205	NP 25	83.10	UCP 305	175.00	MP 25	133.00
30	UCP 206	NP 30	101.00	UCP 306	211.00	MP 30	159.00
35	UCP 207	NP 35	118.00	UCP 307	249.00	MP 35	170.00
40	UCP 208	NP 40	136.00	UCP 308	298.00	MP 40	193.00
45	UCP 209	NP 45	155.00	UCP 309	352.00	MP 45	227.00
50	UCP 210	NP 50	180.00	UCP 310	439.00	MP 50	285.00
55	UCP 211	NP 55	236.00	UCP 311	529.00	MP 55	361.00
60	UCP 212	NP 60	297.00	UCP 312	635.00	MP 60	429.00
65	UCP 213	NP 65	387.00	UCP 313	729.00	MP 65	610.00
70	UCP 214	NP 70	545.00	UCP 314	805.00	MP 70	610.00
75	UCP 215	NP 75	606.00	UCP 315	1027.00	MP 75	703.00
80	UCP 216	NP 80	713.00	UCP 316	1239.00	MP 80	840.00
85	UCP 217	NP 85	795.00	UCP 317	1375.00	MP 85	1101.00
90	UCP 218	NP 90	1166.00	UCP 318	1558.00	MP 90	1101.00
95				UCP 319	*	MP 95	1650.00
100				UCP 320	2150.00	MP 100	1650.00
105				UCP 321	*		
110				UCP 322	2906.00		
120				UCP 324	3988.00		
130				UCP 326	5277.00		
140				UCP 328	6340.00		

¹⁾ Befestigungsdurchmesser und Befestigungslochabstand kann variieren
Diamètre et distance de trou de montage peut varier

Gehäuselager mit Lagereinsatz, Bohrung in Zollabmessung auf Anfrage.
Paliers avec roulement, diamètre de l'alésage en pouces sur demande.

Stehlager mit Gussgehäuse und Spannhülse

Paliers à semelle en fonte avec alésage conique et manchon

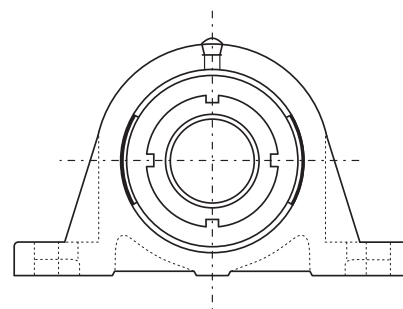

Reihen | **UKP 2 . . , UKP 3 . .**
Séries | **NP . . K, MP . . K**

Bohrung Alésage mm	Typ Type	Preis ¹⁾ Prix CHF	Typ Type	Preis ¹⁾ Prix CHF	Typ Type	Preis ²⁾ Prix CHF	Typ Type	Preis ²⁾ Prix CHF
20	UKP 205	93.70	UKP 305	*	NP 1025 - 20 K	124.00		
25	UKP 206	116.00	UKP 306	211.00	NP 1030 - 25 K	148.00	MP 1030 - 25 K	169.00
30	UKP 207	139.00	UKP 307	249.00	NP 1035 - 30 K	169.00	MP 1035 - 30 K	194.00
35	UKP 208	162.00	UKP 308	*	NP 1040 - 35 K	194.00	MP 1040 - 35 K	*
40	UKP 209	182.00	UKP 309	357.00	NP 1045 - 40 K	222.00	MP 1045 - 40 K	239.00
45	UKP 210	212.00	UKP 310	439.00	NP 1050 - 45 K	257.00	MP 1050 - 45 K	277.00
50	UKP 211	267.00	UKP 311	529.00	NP 1055 - 50 K	344.00	MP 1055 - 50 K	345.00
55	UKP 212	340.00	UKP 312	635.00				
60	UKP 213	414.00	UKP 313	729.00				
65	UKP 215	595.00	UKP 315	1027.00				
70	UKP 216	615.00	UKP 316	1239.00				
75	UKP 217	845.00	UKP 317	1375.00				
80	UKP 218	1073.00	UKP 318	*				
85			UKP 319	1801.00				
90			UKP 320	2150.00				
100			UKP 322	*				
110			UKP 324	*				
115			UKP 326	*				
125			UKP 328	*				

¹⁾ Preise ohne Spannhülse, Hülse H 23 . . siehe Seite 47
Prix sans manchon de serrage, manchon H 23 . . voir page 47

²⁾ Preise inklusive Spannhülse
Prix y compris manchon de serrage

Stehlager mit Gussgehäuse

Paliers à semelle en fonte avec roulement

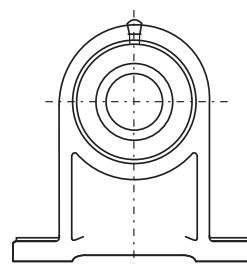

Reihe | **UCPH 2 . .**
Série

Bohrung Alésage mm	Typ Type	Preis Prix CHF
12	UCPH 201	*
15	UCPH 202	85.20
17	UCPH 203	85.20
20	UCPH 204	85.20
25	UCPH 205	104.00
30	UCPH 206	121.00
35	UCPH 207	140.00
40	UCPH 208	160.00
45	UCPH 209	183.00
50	UCPH 210	210.00

Stehlager mit Gussgehäuse

Paliers à semelle en fonte avec roulement

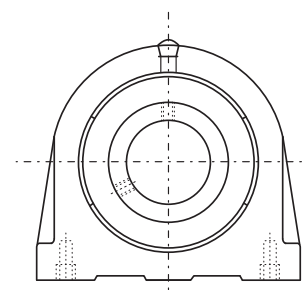

Reihen | **UCPA 2 . .**
Séries | **SNP . .**

Bohrung Alésage mm	Typ Type	Preis Prix CHF	Typ Type	Preis Prix CHF
12	UCPA 201	90.60	SNP 12	*
15	UCPA 202	90.60	SNP 15	*
17	UCPA 203	90.60	SNP 17	*
20	UCPA 204	90.60	SNP 20	77.10
25	UCPA 205	109.00	SNP 25	92.00
30	UCPA 206	123.00	SNP 30	115.00
35	UCPA 207	146.00	SNP 35	134.00
40	UCPA 208	187.00	SNP 40	157.00
45	UCPA 209	210.00	SNP 45	176.00
50	UCPA 210	*	SNP 50	197.00
55	UCPA 211	*	SNP 55	*
60	UCPA 212	*	SNP 60	319.00

* auf Anfrage
sur demande

Flanschlager mit Gussgehäuse

Paliers-appliques en fonte avec roulement

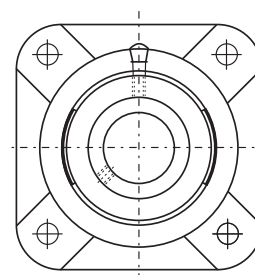

Reihen | **UCF 2 . . , UCF 3 . .**
Séries | **SF . . , MSF . .**

Bohrung Alésage mm	Typ ¹⁾ Type		Preis Prix CHF	Typ Type	Preis Prix CHF	Typ Type	Preis Prix CHF
12	UCF 201	SF 12	70.40				
15	UCF 202	SF 15	70.40				
17	UCF 203	SF 17	70.40				
20	UCF 204	SF 20	70.40				
25	UCF 205	SF 25	83.10	UCF 305	211.00	MSF 25	123.00
30	UCF 206	SF 30	101.00	UCF 306	211.00	MSF 30	142.00
35	UCF 207	SF 35	118.00	UCF 307	249.00	MSF 35	166.00
40	UCF 208	SF 40	136.00	UCF 308	298.00	MSF 40	186.00
45	UCF 209	SF 45	155.00	UCF 309	352.00	MSF 45	227.00
50	UCF 210	SF 50	180.00	UCF 310	439.00	MSF 50	285.00
55	UCF 211	SF 55	236.00	UCF 311	529.00	MSF 55	361.00
60	UCF 212	SF 60	297.00	UCF 312	635.00	MSF 60	429.00
65	UCF 213	SF 65	387.00	UCF 313	729.00	MSF 65	610.00
70	UCF 214	SF 70	545.00	UCF 314	805.00	MSF 70	610.00
75	UCF 215		606.00	UCF 315	1027.00	MSF 75	703.00
80	UCF 216		713.00	UCF 316	1239.00	MSF 80	840.00
85	UCF 217		*	UCF 317	1375.00	MSF 85	1101.00
90	UCF 218		1166.00	UCF 318	1558.00	MSF 90	1101.00
95				UCF 319	1801.00	MSF 95	1650.00
100				UCF 320	2150.00	MSF 100	1650.00
105				UCF 321	*		
110				UCF 322	2906.00		
120				UCF 324	3988.00		
130				UCF 326	5277.00		
140				UCF 328	6340.00		

¹⁾ Befestigungsdurchmesser kann variieren
Diamètre de montage peut varier

Flanschlager mit Gussgehäuse und Spannhülse

Paliers-appliques en fonte avec alésage conique et manchon

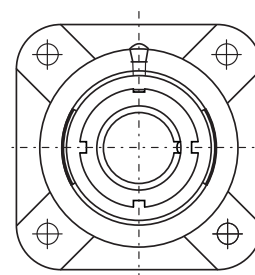

Reihen | **UKF 2 . . , UKF 3 . .**
Séries | **MSF . . K**

Bohrung Alésage mm	Typ Type	Preis ¹⁾ Prix CHF	Typ Type	Preis ¹⁾ Prix CHF	Typ Type	Preis ²⁾ Prix CHF
20	UKF 205	93.70	UKF 305	*	MSF 1025 - 20 K	122.00
25	UKF 206	116.00	UKF 306	*	MSF 1030 - 25 K	158.00
30	UKF 207	139.00	UKF 307	*	MSF 1035 - 30 K	237.00
35	UKF 208	162.00	UKF 308	298.00	MSF 1040 - 35 K	244.00
40	UKF 209	182.00	UKF 309	357.00	MSF 1045 - 40 K	259.00
45	UKF 210	212.00	UKF 310	439.00	MSF 1050 - 45 K	341.00
50	UKF 211	267.00	UKF 311	529.00	MSF 1055 - 50 K	419.00
55	UKF 212	340.00	UKF 312	635.00		
60	UKF 213	414.00	UKF 313	729.00		
65	UKF 215	595.00	UKF 315	1027.00		
70	UKF 216	705.00	UKF 316	1239.00		
75	UKF 217	845.00	UKF 317	1375.00		
80	UKF 218	1073.00	UKF 318	1558.00		
85			UKF 319	*		
90			UKF 320	*		
100			UKF 322	*		
110			UKF 324	*		
115			UKF 326	*		
125			UKF 328	*		

¹⁾ Preise ohne Spannhülse, Hülse H 23 . . siehe Seite 47
Prix sans manchon de serrage, manchon H 23 . . voir page 47

²⁾ Preise inklusive Spannhülse
Prix y compris manchon de serrage

Flanschlager mit Gussgehäuse

Paliers-appliques en fonte avec roulement

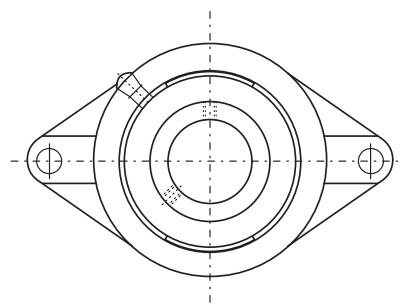

Reihen | **UCFL 2 . . , UCFL 3 . .**
Séries | **SFT . . , MSFT . .**

Bohrung Alésage mm	Typ ¹⁾ Type		Preis Prix CHF	Typ Type	Preis Prix CHF	Typ Type	Preis Prix CHF
12	UCFL 201	SFT 12	70.40				
15	UCFL 202	SFT 15	70.40				
17	UCFL 203	SFT 17	70.40				
20	UCFL 204	SFT 20	70.40				
25	UCFL 205	SFT 25	83.10	UCFL 305	175.00	MSFT 25	161.00
30	UCFL 206	SFT 30	101.00	UCFL 306	211.00	MSFT 30	199.00
35	UCFL 207	SFT 35	118.00	UCFL 307	249.00	MSFT 35	203.00
40	UCFL 208	SFT 40	136.00	UCFL 308	298.00	MSFT 40	223.00
45	UCFL 209	SFT 45	155.00	UCFL 309	352.00	MSFT 45	259.00
50	UCFL 210	SFT 50	180.00	UCFL 310	439.00	MSFT 50	288.00
55	UCFL 211	SFT 55	236.00	UCFL 311	*	MSFT 55	355.00
60	UCFL 212	SFT 60	297.00	UCFL 312	*		
65	UCFL 213		387.00	UCFL 313	*		
70	UCFL 214		545.00	UCFL 314	*		
75	UCFL 215		606.00	UCFL 315	*		
80	UCFL 216		651.00	UCFL 316	*		
85	UCFL 217		*	UCFL 317	*		
90	UCFL 218		817.00	UCFL 318	*		
95				UCFL 319	*		
100				UCFL 320	*		
105				UCFL 321	*		
110				UCFL 322	*		
120				UCFL 324	*		
130				UCFL 326	*		
140				UCFL 328	*		

¹⁾ Befestigungsdurchmesser kann variieren
Diamètre de montage peut varier

Flanschlager mit Gussgehäuse und Spannhülse

Paliers-appliques en fonte avec alésage conique et manchon

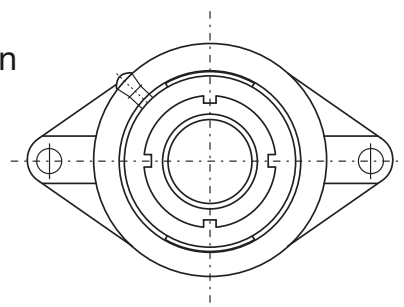

Reihen | **UKFL 2 . . , UKFL 3 . .**
Séries | **MSFT . . K**

Bohrung Alésage mm	Typ Type	Preis ¹⁾ Prix CHF	Typ Type	Preis ¹⁾ Prix CHF	Typ Type	Preis ²⁾ Prix CHF
20	UKFL 205	93.70	UKFL 305	*	MSFT 1025 - 20K	160.00
25	UKFL 206	116.00	UKFL 306	*	MSFT 1030 - 25K	195.00
30	UKFL 207	139.00	UKFL 307	*	MSFT 1035 - 30K	235.00
35	UKFL 208	162.00	UKFL 308	*	MSFT 1040 - 35K	242.00
40	UKFL 209	182.00	UKFL 309	*	MSFT 1045 - 40K	305.00
45	UKFL 210	212.00	UKFL 310	*	MSFT 1050 - 45K	338.00
50	UKFL 211	267.00	UKFL 311	*	MSFT 1055 - 50K	418.00
55	UKFL 212	340.00	UKFL 312	*		
60	UKFL 213	414.00	UKFL 313	*		
65	UKFL 215	595.00	UKFL 315	*		
70	UKFL 216	*	UKFL 316	*		
75	UKFL 217	*	UKFL 317	*		
80	UKFL 218	1073.00	UKFL 318	*		
85			UKFL 319	*		
90			UKFL 320	*		
100			UKFL 322	*		
110			UKFL 324	*		
115			UKFL 326	*		
125			UKFL 328	*		

¹⁾ Preise ohne Spannhülse, Hülse H 23 . . siehe Seite 47
Prix sans manchon de serrage, manchon H 23 . . voir page 47

²⁾ Preise inklusive Spannhülse
Prix y compris manchon de serrage

Flanschlager mit Gussgehäuse

Paliers-appliques en fonte avec roulement

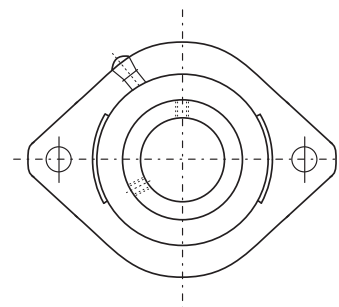

Reihe | **LFTC . . . , LFTC . . . A**
Série

Bohrung Alésage mm	Typ Type	Preis Prix CHF
12	LFTC 12	73.60
15	LFTC 15 (A)	73.60
17	LFTC 17 (A)	73.60
20	LFTC 20 (A)	78.40
25	LFTC 25 (A)	86.20
30	LFTC 30 (A)	105.00
35	LFTC 35 (A)	124.00

Flanschlager mit Gussgehäuse mit Zentrieransatz

Paliers-appliques en fonte avec roulement et épaulement de centrage

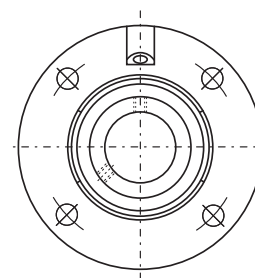

Reihe | **FC . . . , FC . . . A**
Série

Bohrung Alésage mm	Typ Type	Preis Prix CHF
20	FC 20 (A)	80.60
25	FC 25 (A)	95.60
30	FC 30 (A)	117.00
35	FC 35 (A)	134.00
40	FC 40 (A)	157.00
45	FC 45 (A)	178.00
50	FC 50 (A)	197.00
55	FC 55	*
60	FC 60	319.00

Flanschlager mit Gussgehäuse mit Zentrieransatz

Paliers-appliques en fonte avec roulement et épaulement de centrage

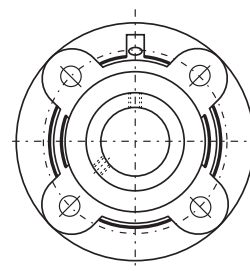

Reihen | **UCFC 2 . . , UKFC 2 . .**
Séries | **MFC . .**

Bohrung Alésage mm	Typ Type	Preis Prix CHF	Typ Type	Preis Prix CHF	Typ Type	Preis ¹⁾ Prix CHF
12	UCFC 201	*				
15	UCFC 202	*				
17	UCFC 203	*				
20	UCFC 204	84.30			UKFC 205	118.00
25	UCFC 205	99.60	MFC 25	170.00	UKFC 206	141.00
30	UCFC 206	122.00	MFC 30	187.00	UKFC 207	164.00
35	UCFC 207	139.00	MFC 35	209.00	UKFC 208	193.00
40	UCFC 208	164.00	MFC 40	209.00	UKFC 209	224.00
45	UCFC 209	186.00	MFC 45	261.00	UKFC 210	249.00
50	UCFC 210	207.00	MFC 50	308.00	UKFC 211	310.00
55	UCFC 211	255.00	MFC 55	351.00	UKFC 212	389.00
60	UCFC 212	328.00	MFC 60	478.00	UKFC 213	453.00
65	UCFC 213	444.00	MFC 65	567.00	UKFC 215	772.00
70	UCFC 214	583.00	MFC 70	567.00	UKFC 216	866.00
75	UCFC 215	666.00	MFC 75	667.00	UKFC 217	1037.00
80	UCFC 216	787.00	MFC 80	686.00	UKFC 218	1183.00
85	UCFC 217	1034.00	MFC 85	1152.00		
90	UCFC 218	1367.00	MFC 90	1152.00		
95			MFC 95	1771.00		
100			MFC 100	1772.00		

¹⁾ Preise ohne Spannhülse, Hülse H 23 . . siehe Seite 47
Prix sans manchon de serrage, manchon H 23 . . voir page 47

Spannlager mit Gussgehäuse

Coulisseaux tendeurs en fonte avec roulement

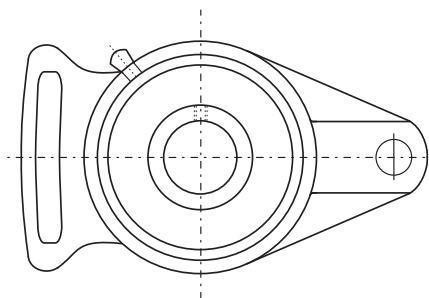

Reihe | **UCFA 2 . .**
Série

Bohrung Alésage mm	Typ Type	Preis Prix CHF
12	UCFA 201	99.50
15	UCFA 202	99.50
17	UCFA 203	99.50
20	UCFA 204	99.50
25	UCFA 205	118.00
30	UCFA 206	142.00
35	UCFA 207	167.00
40	UCFA 208	181.00
45	UCFA 209	212.00
50	UCFA 210	240.00
55	UCFA 211	313.00
60	UCFA 212	*
65	UCFA 213	*
70	UCFA 214	*
75	UCFA 215	*
80	UCFA 216	*
85	UCFA 217	*
90	UCFA 218	*

Spannlager mit Gussgehäuse

Coulisseaux tendeurs en fonte avec roulement

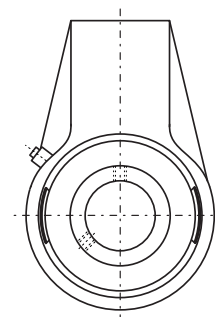

Reihen | **UCEH 2 . .**
Séries | **SCHB . ., SCH . .**

Bohrung Alésage mm	Typ Type	Preis Prix CHF	Typ Type	Preis Prix CHF
12	UCEH 201	*		
15	UCEH 202	*		
17	UCEH 203	*		
20	UCEH 204	*	SCHB 20 SCH 20	128.00
25	UCEH 205	*	SCHB 25 SCH 25	139.00
30	UCEH 206	*	SCHB 30 SCH 30	139.00
35	UCEH 207	*	SCHB 35 SCH 35	175.00
40	UCEH 208	*	SCHB 40 SCH 40	201.00
45	UCEH 209	*	SCHB 45 SCH 45	253.00
50	UCEH 210	*	SCHB 50 SCH 50	253.00
55	UCEH 211	*	SCHB 55 SCH 55	372.00
60	UCEH 212	*	SCHB 60 SCH 60	372.00
65			SCHB 65	545.00
70			SCHB 70	545.00
75			SCHB 75	545.00
80			SCHB 80 SCH 80	635.00

Hülsenlager mit Gussgehäuse

Cartouches en fonte avec roulement

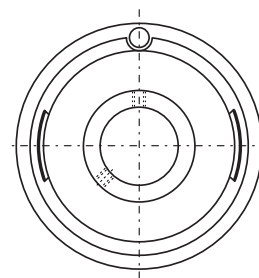

Reihen | **UCC 2 . . , UCC 3 . .**
Séries | **SLC . .**

Bohrung Alésage mm	Typ Type	Preis Prix CHF	Typ Type	Preis Prix CHF	Typ Type	Preis Prix CHF
12					SLC 12	*
15					SLC 15	75.20
17					SLC 17	75.20
20	UCC 204	95.20			SLC 20	75.20
25	UCC 205	113.00	UCC 305	*	SLC 25	87.50
30	UCC 206	136.00	UCC 306	*	SLC 30	112.00
35	UCC 207	160.00	UCC 307	*	SLC 35	132.00
40	UCC 208	173.00	UCC 308	*	SLC 40	158.00
45	UCC 209	202.00	UCC 309	*	SLC 45	175.00
50	UCC 210	230.00	UCC 310	*	SLC 50	207.00
55	UCC 211	299.00	UCC 311	*	SLC 55	285.00
60	UCC 212	362.00	UCC 312	*	SLC 60	339.00
65	UCC 213	444.00	UCC 313	*	SLC 65	482.00
70	UCC 214	*	UCC 314	*		
75	UCC 215	*	UCC 315	*		
80	UCC 216	*	UCC 316	*		
85	UCC 217	*	UCC 317	*		
90	UCC 218	*	UCC 318	*		
95			UCC 319	*		
100			UCC 320	*		
105			UCC 321	*		
110			UCC 322	*		
120			UCC 324	*		
130			UCC 326	*		
140			UCC 328	*		

Spannlager mit Gussgehäuse

Coulisseaux tendeurs en fonte avec roulement

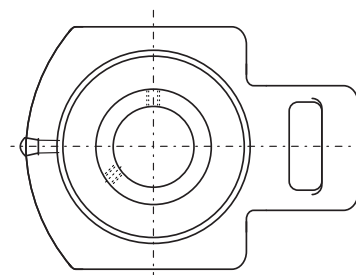

Reihen | **UCT 2 . . , UCT 3 . .**
Séries | **ST . .**

Bohrung Alésage mm	Typ ¹⁾ Type	Preis Prix CHF	Typ ¹⁾ Type	Preis Prix CHF	Typ ¹⁾ Type	Preis Prix CHF
12	UCT 201	80.60				
15	UCT 202	80.60				
17	UCT 203	80.60				
20	UCT 204	80.60			ST 20	80.60
25	UCT 205	95.60	UCT 305	*	ST 25	95.60
30	UCT 206	117.00	UCT 306	215.00	ST 30	117.00
35	UCT 207	134.00	UCT 307	251.00	ST 35	134.00
40	UCT 208	173.00	UCT 308	300.00	ST 40	173.00
45	UCT 209	202.00	UCT 309	*	ST 45	202.00
50	UCT 210	197.00	UCT 310	462.00	ST 50	197.00
55	UCT 211	299.00	UCT 311	*	ST 55	299.00
60	UCT 212	319.00	UCT 312	657.00	ST 60	319.00
65	UCT 213	*	UCT 313	756.00	ST 65	565.00
70	UCT 214	587.00	UCT 314	873.00	ST 70	587.00
75	UCT 215	731.00	UCT 315	1047.00	ST 75	731.00
80	UCT 216	838.00	UCT 316	1267.00	ST 80	838.00
85	UCT 217	*	UCT 317	1455.00	ST 85	1448.00
90	UCT 218	*	UCT 318	1648.00		
95			UCT 319	*		
100			UCT 320	2336.00		
105			UCT 321	*		
110			UCT 322	*		
120			UCT 324	*		
130			UCT 326	*		
140			UCT 328	*		

¹⁾Breite der Führungsnut kann variieren
Largeur de guide de rainure peut varier

Transportbandspanner mit Gussgehäuse

Tendeurs en fonte avec roulement
(pour bandes transporteuses)

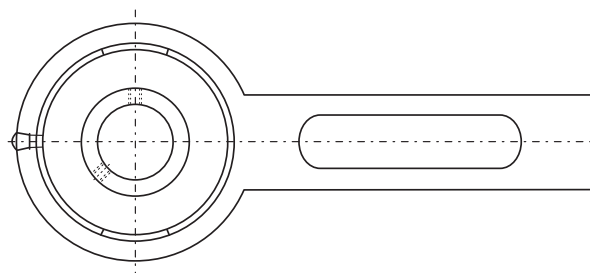

Reihe | **BT ..**
Série

Bohrung Alésage mm	Typ Type	Preis Prix CHF
25	BT 25	196.00
30	BT 30	*
35	BT 35	249.00

Stehlager mit Stahlblechgehäuse (und Gummidämmring)

Paliers à semelle en tôle d'acier avec
roulement (et amortisseur en caoutchouc)

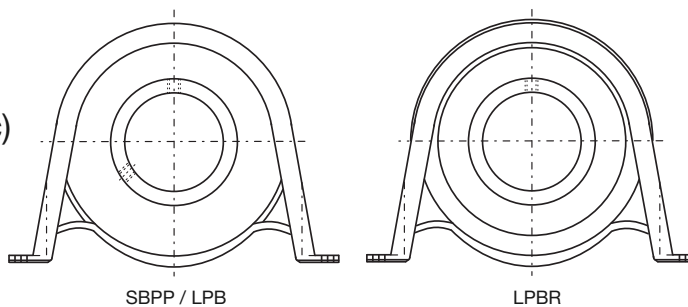

Reihen | **SBPP 2 ..**
Séries | **LPB .., LPB .. A, LPBR ..**

Bohrung Alésage mm	Typ Type	Preis Prix CHF	Typ Type	Preis Prix CHF	Typ Type	Preis Prix CHF	
12	SBPP 201	LPB 12 A	50.20	LPB 12	57.00	LPBR 12	79.00
15	SBPP 202	LPB 15 A	50.20	LPB 15	57.00	LPBR 15	79.00
17	SBPP 203	LPB 17 A	50.20	LPB 17	57.00	LPBR 17	79.00
20	SBPP 204	LPB 20 A	51.50	LPB 20	58.30	LPBR 20	87.10
25	SBPP 205	LPB 25 A	58.20	LPB 25	66.20	LPBR 25	96.10
30	SBPP 206	LPB 30 A	70.40	LPB 30	77.60	LPBR 30	122.00
35	SBPP 207	LPB 35 A	82.70	LPB 35	94.80		

Flanschlager mit Stahlblechgehäuse

Paliers-appliques en tôle d'acier avec roulement

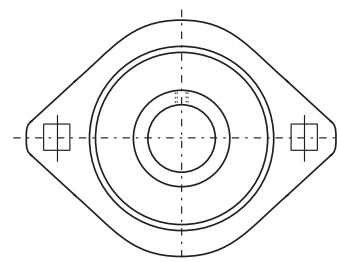

Reihen | **SBPFL 2 . .**
Séries | **SLFL . . , SLFL . . A**

Bohrung Alésage mm	Typ Type		Preis Prix CHF		Typ Type	Preis Prix CHF
12	SBPFL 201	SLFL 12 A	50.20		SLFL 12	57.00
15	SBPFL 202	SLFL 15 A	50.20		SLFL 15	57.00
17	SBPFL 203	SLFL 17 A	50.20		SLFL 17	57.00
20	SBPFL 204	SLFL 20 A	51.50		SLFL 20	58.30
25	SBPFL 205	SLFL 25 A	58.20		SLFL 25	66.20
30	SBPFL 206	SLFL 30 A	70.40		SLFL 30	77.60
35	SBPFL 207	SLFL 35 A	86.50			

Flanschlager mit Stahlblechgehäuse

Paliers-appliques en tôle d'acier avec roulement

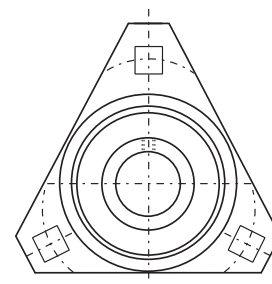

Reihe | **SLFT . . , SLFT . . A**
Série

Bohrung Alésage mm	Typ Type	Preis Prix CHF
25	SLFT 25 (A)	58.20
30	SLFT 30 (A)	70.40
35	SLFT 35 (A)	86.50

Flanschlager mit Stahlblechgehäuse

Paliers-appliques en tôle d'acier avec roulement

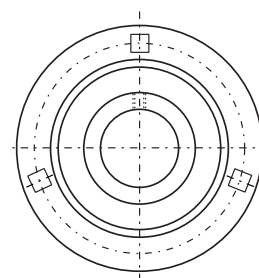

Reihen | **SBPF 2 ..**
Séries | **SLFE .., SLFE .. A**

Bohrung Alésage mm	Typ Type		Preis Prix CHF	Typ Type	Preis Prix CHF
12	SBPF 201	SLFE 12 A	50.20	SLFE 12	57.00
15	SBPF 202	SLFE 15 A	50.20	SLFE 15	57.00
17	SBPF 203	SLFE 17 A	50.20	SLFE 17	57.00
20	SBPF 204	SLFE 20 A	51.50	SLFE 20	58.30
25	SBPF 205	SLFE 25 A	58.20	SLFE 25	66.20
30	SBPF 206	SLFE 30 A	70.40	SLFE 30	77.60
35	SBPF 207	SLFE 35 A	86.50	SLFE 35	94.80
40	SBPF 208	SLFE 40 A	*	SLFE 40	113.00
45	SBPF 209	SLFE 45 A	*	SLFE 45	135.00
50	SBPF 210	SLFE 50 A	*	SLFE 50	159.00
55				SLFE 55	175.00
60				SLFE 60	298.00